

AR

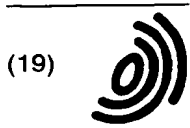

Europäisches Patentamt
European Patent Office
Office européen des brevets



(11) EP 1 306 389 A2

(12) EUROPEAN PATENT APPLICATION

(43) Date of publication:
02.05.2003 Bulletin 2003/18

(51) Int Cl.7: C08B 37/00, C07H 3/06,
C07H 3/04

(21) Application number: 02023064.5

(22) Date of filing: 16.10.2002

(84) Designated Contracting States:
AT BE BG CH CY CZ DE DK EE ES FI FR GB GR
IE IT LI LU MC NL PT SE SK TR
Designated Extension States:
AL LT LV MK RO SI

- Amarume, Hitomi
Hirosaki-shi, Aomori (JP)
- Kawai, Takashi
Kusatsu-shi, Shiga (JP)
- Kojima, Kaoru
Hirosaki-shi, Aomori (JP)
- Shimanaka, Kazuo
Takatsuki-shi, Osaka (JP)
- Ikai, Katsushige
Koka-gun, Shiba (JP)
- Kato, Ikunoshin
Uji-shi, Kyoto (JP)

(30) Priority: 24.10.2001 JP 2001325960

(83) Declaration under Rule 28(4) EPC (expert
solution)

(71) Applicant: TAKARA BIO INC.
Otsu-shi, Shiga (JP)

(74) Representative: Grund, Martin, Dr. et al
Dr. Volker Vossius
Patent- & Rechtsanwaltskanzlei
Geibelstrasse 6
81679 München (DE)

(72) Inventors:
• Sakai, Takeshi
Kusatsu-shi, Shiga (JP)

(54) Sulfated fucan oligosaccharide

(57) A smaller molecule obtainable by allowing a sulfated fucan-digesting enzyme which digests a novel sulfated polysaccharide derived from an alga belonging to Laminariales to act on a sulfated fucan, and a method for producing the same.

EP 1 306 389 A2

Description

BACKGROUND OF THE INVENTION

5 Field of the Invention

[0001] The present invention relates to a sulfated fucan oligosaccharide which is useful in a field of glycotecology, and a method for producing the same.

10 Description of Related Art

[0002] Brown algae contain a variety of sulfated polysaccharides. These polysaccharides are often generically called fucoidans or fucoidins. In many cases, their structures vary depending on the algae from which they derive. For example, sulfated polysaccharides extracted from *Fucus vesiculosus*, *Laminaria japonica*, *Cladosiphon okamuranus*,
15 *Nemacystus decipiens* and sporophyll of *Undaria pinnatifida* have structures different each other. Therefore, it is necessary to obtain enzymes that digest the respective sulfated polysaccharides in order to obtain oligosaccharides from the sulfated polysaccharides by enzymatically digesting them or to determine their structures.

[0003] Molecular species of sulfated polysaccharides including sulfated fucans, sulfated fucoglucuronomannans and sulfated fucogalactans as well as several other molecular species have been reported. Sulfated polysaccharides generally have some biological activities in many cases. For example, a sulfated fucan has been reported to have an apoptosis-inducing activity against tumor cells.

[0004] If a sulfated polysaccharide is to be developed as a pharmaceutical, it is necessary to determine its structure. It is very advantageous to determine the structure using an enzyme that digests the sulfated polysaccharide. However,
25 no enzyme that digests a sulfated polysaccharide from a brown alga is commercially available. In addition, a digesting enzyme that specifically digests the sulfated polysaccharide of which the structure is to be determined is required. This is because sulfated polysaccharides from brown algae vary depending on the species of the algae in many cases. Structures of sulfated polysaccharides derived from algae belonging to Laminariales have been studied, although structures have been revealed only for a few kinds among many molecular species.

[0005] As described above, a structurally homogeneous sulfated fucan oligosaccharide which is produced by enzymatic means using an enzyme that digests a novel sulfated polysaccharide derived from an alga belonging to Lami-
30 nariales (i.e., an enzyme that specifically digests a sulfated fucan) has been desired.

[0006] Thus, the main object of the present invention is to provide a smaller molecule obtainable by allowing a sulfated fucan-digesting enzyme which digests a novel sulfated polysaccharide derived from an alga belonging to Laminariales
35 to act on a sulfated fucan, and a method for producing the same.

SUMMARY OF THE INVENTION

[0007] The first aspect of the present invention relates to a sulfated fucan having the following chemical and physical
40 properties:

- (1) containing fucose as a constituting saccharide;
- (2) containing a sulfated saccharide of general formula (I) as an essential component of the constituting saccharide:

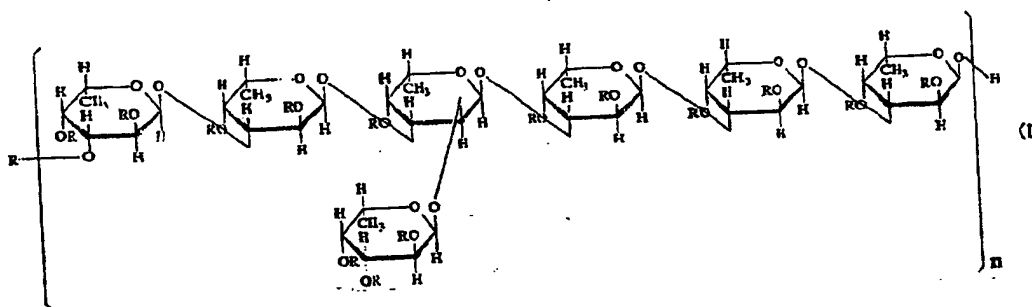

wherein R is H or SO₃H, at least one of Rs is SO₃H and n is an integer of 1 or more; and

(3) being converted into smaller molecules by a sulfated fucan-digesting enzyme derived from *Alteromonas* sp. SN-1009 to generate at least one compound selected from the group consisting of the compounds of general formulas (II), (III), (XIII), (XIV), (XV) and (XVI):

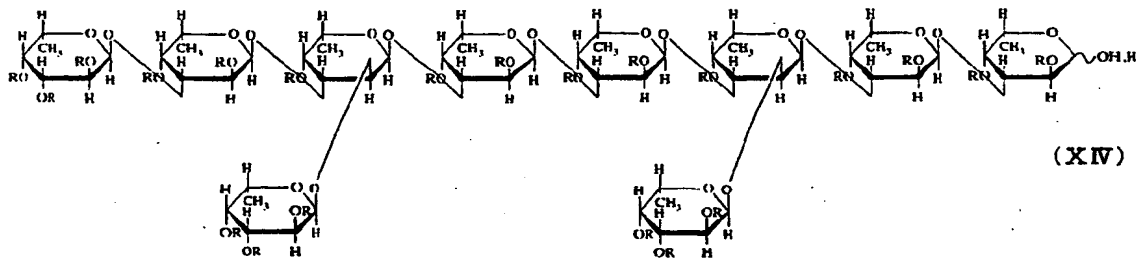
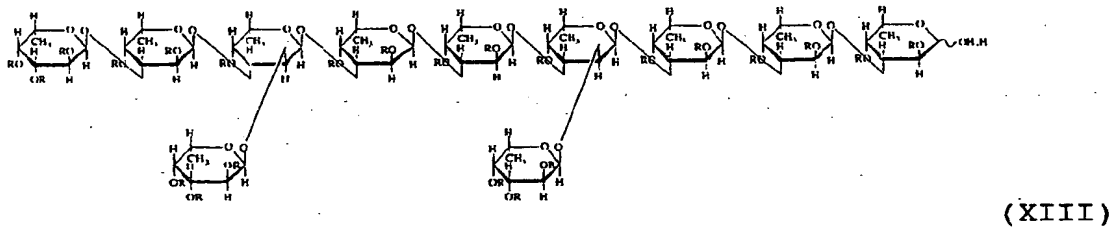
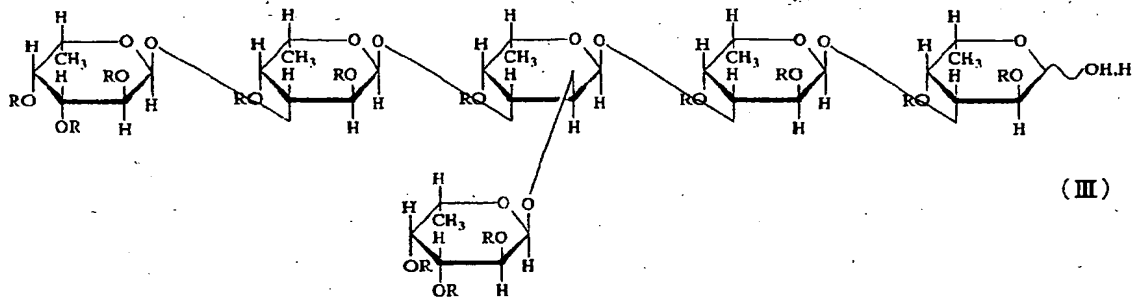
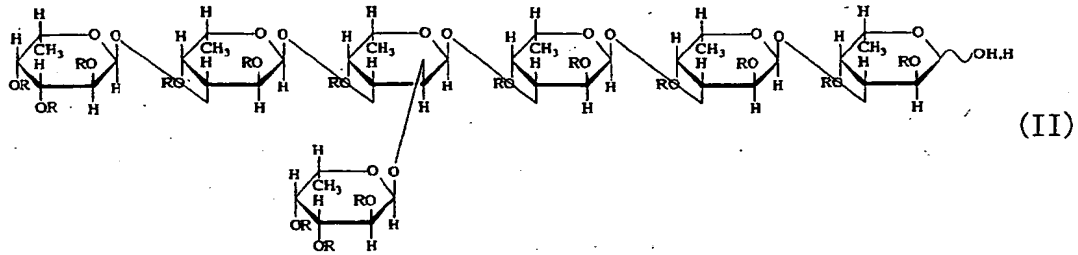

5

10

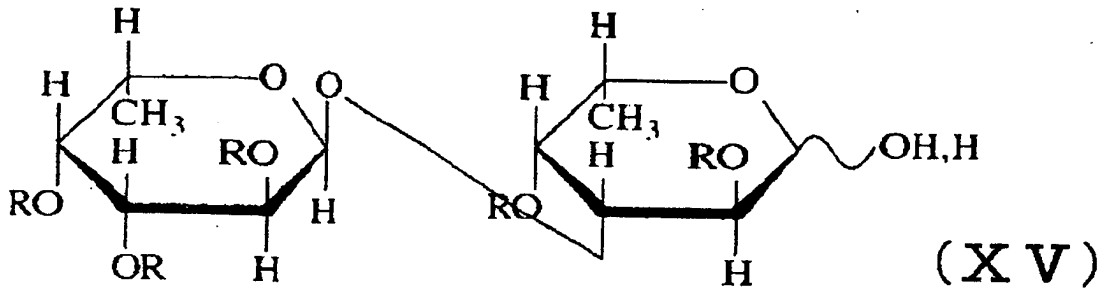

15

and

20

25

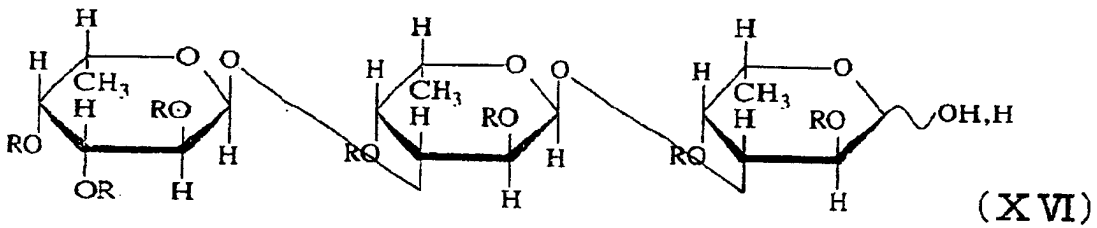

30

wherein R is H or SO₃H and at least one of Rs is SO₃H in all formulas above, or a salt thereof.

[0008] The second aspect of the present invention relates to a sulfated fucan oligosaccharide of general formula (I):

35

40

45

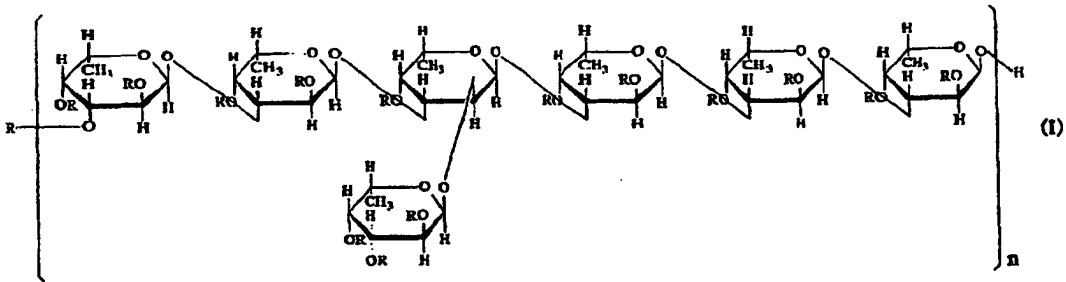

wherein R is H or SO₃H, at least one of Rs is SO₃H and n is 1 to 5.

50

[0009] The third aspect of the present invention relates to a method for preparing a sulfated fucan oligosaccharide, the method comprising:

- allowing a sulfated fucan-digesting enzyme derived from *Alteromonas* sp. SN-1009 to act on a sulfated fucan of the first or second aspect; and
- collecting a digestion product.

55

[0010] According to the third aspect, the sulfated fucan is derived from *Kjellmaniella crassifolia*, *Laminaria japonica* or *Lessonia nigrescens*.

[0011] The fourth aspect of the present invention relates to a sulfated fucan oligosaccharide obtainable by the preparation method of the third aspect.

[0012] The fifth aspect of the present invention relates to a sulfated fucan oligosaccharide having a chemical structure selected from the group consisting of general formulas (II), (III), (XIII), (XIV), (XV) and (XVI):

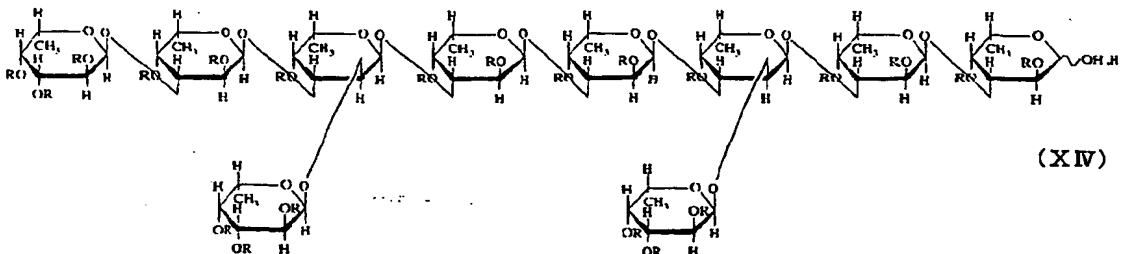
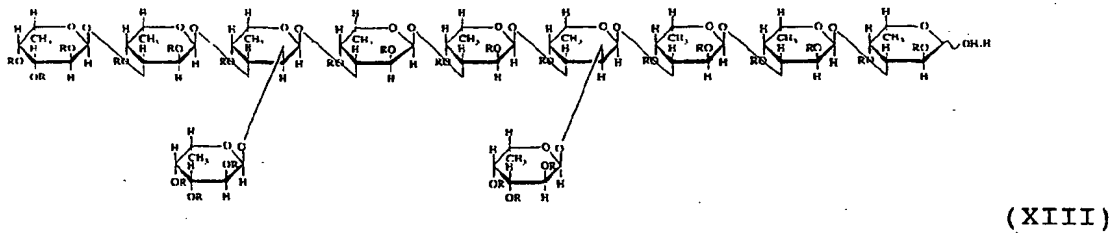
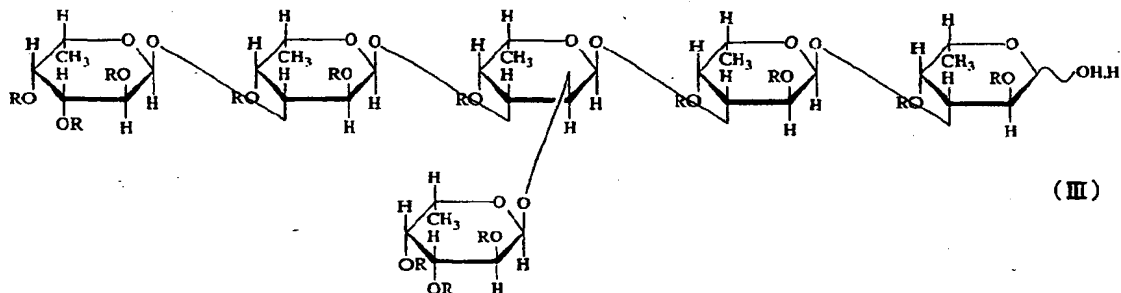
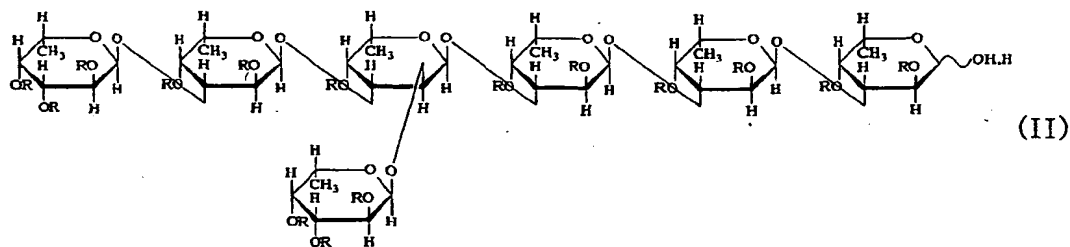

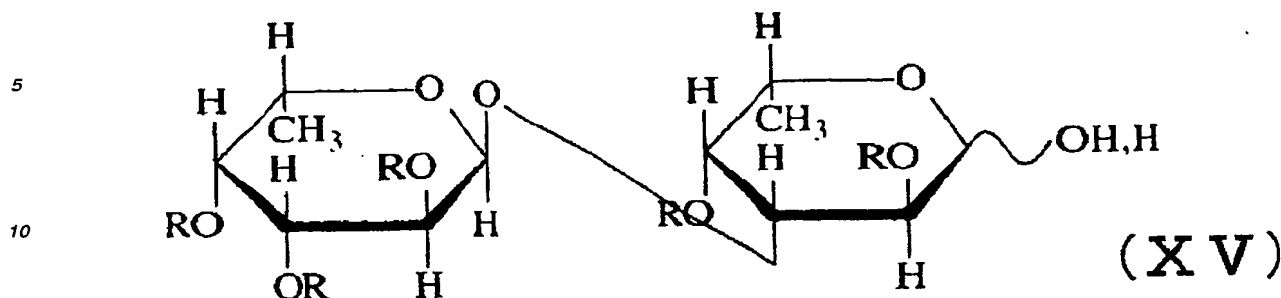

15 and

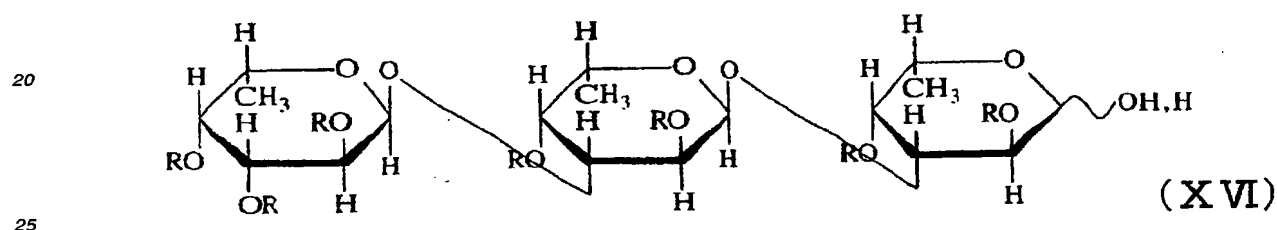

wherein R is H or SO₃H and at least one of Rs is SO₃H in all formulas above, or a salt thereof.

[0013] As a result of intensive study, the present inventors have found a method for producing a sulfated fucan oligosaccharide by digesting a novel sulfated polysaccharide derived from a alga belonging to Laminariales using a sulfated fucan-digesting enzyme. The sulfated fucan oligosaccharide can be utilized as a reagent for glycotecnology and is structurally homogeneous. Furthermore, the present inventors have determined the structure of the oligosaccharide. Thus, the present invention has been completed.

BRIEF DESCRIPTION OF THE SEVERAL VIEWS OF THE DRAWINGS

[0014] Figure 1: a figure which illustrates the ¹H-NMR spectrum of the sulfated fucan oligosaccharide 1-(1) according to the present invention.

[0015] Figure 2: a figure which illustrates the ¹³C-NMR spectrum of the sulfated fucan oligosaccharide 1-(1) according to the present invention.

[0016] Figure 3: a figure which illustrates the mass spectrum of the sulfated fucan oligosaccharide 1-(1) according to the present invention.

[0017] Figure 4: a figure which illustrates the ¹H-NMR spectrum of the sulfated fucan oligosaccharide 1-(2) according to the present invention.

[0018] Figure 5: a figure which illustrates the ¹³C-NMR spectrum of the sulfated fucan oligosaccharide 1-(2) according to the present invention.

[0019] Figure 6: a figure which illustrates the mass spectrum of the sulfated fucan oligosaccharide 1-(2) according to the present invention.

[0020] Figure 7: a figure which illustrates the ¹H-NMR spectrum of the sulfated fucan oligosaccharide 1-(3) according to the present invention.

[0021] Figure 8: a figure which illustrates the ¹³C-NMR spectrum of the sulfated fucan oligosaccharide 1-(3) according to the present invention.

[0022] Figure 9: a figure which illustrates the mass spectrum of the sulfated fucan oligosaccharide 1-(3) according to the present invention.

[0023] Figure 10: a figure which illustrates the ¹H-NMR spectrum of the sulfated fucan oligosaccharide 1-(4) according to the present invention.

[0024] Figure 11: a figure which illustrates the ¹³C-NMR spectrum of the sulfated fucan oligosaccharide 1-(4) according to the present invention.

[0025] Figure 12: a figure which illustrates the mass spectrum of the sulfated fucan oligosaccharide 1-(4) according to the present invention.

[0026] Figure 13: a figure which illustrates the ¹H-NMR spectrum of the sulfated fucan oligosaccharide 2-(1)-2 according to the present invention.

[0027] Figure 14: a figure which illustrates the ¹³C-NMR spectrum of the sulfated fucan oligosaccharide 2-(1)-2 according to the present invention.

[0028] Figure 15: a figure which illustrates the mass spectrum of the sulfated fucan oligosaccharide 2-(1)-2 according to the present invention.

[0029] Figure 16: a figure which illustrates the ¹H-NMR spectrum of the sulfated fucan oligosaccharide 2-(2) according to the present invention.

[0030] Figure 17: a figure which illustrates the ¹³C-NMR spectrum of the sulfated fucan oligosaccharide 2-(2) according to the present invention.

[0031] Figure 18: a figure which illustrates the mass spectrum of the sulfated fucan oligosaccharide 2-(2) according to the present invention.

[0032] Figure 19: a figure which illustrates the ¹H-NMR spectrum of the *Lessonia nigrescens* sulfated fucan oligosaccharide 1-(1) according to the present invention.

[0033] Figure 20: a figure which illustrates the ¹³C-NMR spectrum of the *Lessonia nigrescens* sulfated fucan oligosaccharide 1-(1) according to the present invention.

[0034] Figure 21: a figure which illustrates the mass spectrum of the *Lessonia nigrescens* sulfated fucan oligosaccharide 1-(1) according to the present invention.

[0035] Figure 22: a figure which illustrates the ¹H-NMR spectrum of the *Lessonia nigrescens* sulfated fucan oligosaccharide 1-(2) according to the present invention.

[0036] Figure 23: a figure which illustrates the ¹³C-NMR spectrum of the *Lessonia nigrescens* sulfated fucan oligosaccharide 1-(2) according to the present invention.

[0037] Figure 24: a figure which illustrates the mass spectrum of the *Lessonia nigrescens* sulfated fucan oligosaccharide 1-(2) according to the present invention.

[0038] Figure 25: a figure which illustrates the ¹H-NMR spectrum of the *Lessonia nigrescens* sulfated fucan oligosaccharide 1-(3) according to the present invention.

[0039] Figure 26: a figure which illustrates the ¹³C-NMR spectrum of the *Lessonia nigrescens* sulfated fucan oligosaccharide 1-(3) according to the present invention.

[0040] Figure 27: a figure which illustrates the mass spectrum of the *Lessonia nigrescens* sulfated fucan oligosaccharide 1-(3) according to the present invention.

DETAILED DESCRIPTION OF THE INVENTION

[0041] The present invention will be explained in detail.

[0042] Although it is not intended to limit the present invention, for example, a sulfated fucan derived from an alga belonging to Laminariales can be used according to the present invention. This polysaccharide has a sulfate group and fucose as main constituents. The main chain of a sulfated fucan derived from an alga belonging to Laminariales is composed of L-fucose which is more acid-labile than general saccharides. Therefore, it can be readily converted into smaller molecules by heating or acid treatment.

[0043] A sulfated fucan having the above-mentioned characteristics can be used according to the present invention. Although there is no specific limitation concerning the origin, for example, algae belonging to Laminariales such as *Kjellmaniella crassifolia*, *Laminaria japonica* and *Lessonia nigrescens* are preferably used as raw materials because their sulfated fucan contents are high.

[0044] The sulfated fucan-digesting enzyme according to the present invention acts on a sulfated fucan, a sulfated fucan oligosaccharide and the like and hydrolyzes an α -L-fucosyl bond between fucoses in an endo-type manner to generate an oligosaccharide having L-fucose at its reducing end.

[0045] The sulfated fucan oligosaccharide of the present invention is an oligosaccharide that is obtainable by allowing the sulfated fucan-digesting enzyme according to the present invention to act on a sulfated fucan and has L-fucose as a saccharide at the reducing end.

[0046] A water-soluble fraction extract is first obtained from a brown alga in order to produce the sulfated fucan used according to the present invention. In this case, it is preferable to obtain the water-soluble fraction extract at pH 4-9 at a temperature of 100°C or below in order to prevent the conversion of the sulfated fucan into smaller molecules. Furthermore, amino acids, small molecule pigments or the like in the extract can be efficiently removed by ultrafiltration. Activated carbon treatment or the like is effective for the removal of hydrophobic substances.

[0047] A sulfated polysaccharide fraction from a brown alga can be obtained as described above. This fraction can be used as a sulfated fucan fraction, for example, as a substrate for the sulfated fucan-digesting enzyme according to

the present invention. A more highly pure sulfated fucan can be obtained by separating the fraction using an anion exchange column. Both the sulfated polysaccharide fraction and the sulfated fucan purified using an anion exchange column can be used as raw materials for production of the sulfated fucan oligosaccharide of the present invention.

[0048] The main backbone of the sulfated fucan of the present invention is represented by general formula (I) below. The sulfated fucans of the present invention include those of the general formula wherein n is an integer of 1 or more, for example 1 to 20,000, preferably 1 to 10,000. The sulfated fucans of the present invention include those having a structure in which general formula (I) is continuously repeated and those having a structure in which general formula (I) is discontinuously included being intervened by other structures as long as they are within the definition as described above.

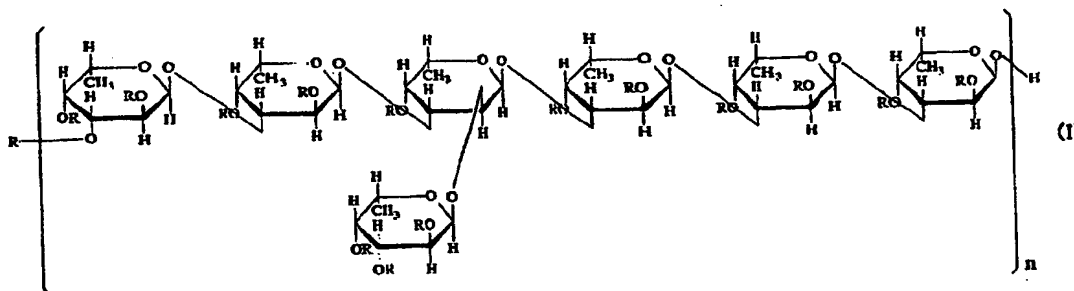

wherein R is H or SO_3H , and at least one of R_s is SO_3H ;

[0049] The bacterial strain producing the sulfated fucan-digesting enzyme to be used according to the present invention is classified as a bacterium belonging to genus *Alteromonas* according to the basic classification as described in Bergey's Manual of Determinative Bacteriology, Vol. 9 (1994). Classification of bacteria belonging to genus *Alteromonas* is recently re-organized. Therefore, it is not appropriate to classify the bacterium based only on the bacteriological properties. The nucleotide sequence of 16S rDNA of this bacterial strain was determined. Comparison of homologies with sequences of known bacteria revealed that a bacterium belonging to genus *Thalassomonas* has the most homologous sequence. However, since the genetic distance is 0.05 (change/average nucleotide position) or more, the bacterium was not determined to belong to this genus. Then, the present inventors concluded that this bacterium does not belong to known genera but belongs to a novel genus based on the 16S rDNA sequence homology, and designated it as *Fucanobacter lyticus* SN-1009. As used herein, *Alteromonas* sp. SN-1009 is the same as *Fucanobacter lyticus* SN-1009.

[0050] This bacterial strain is designated as *Alteromonas* sp. SN-1009 and deposited on February 13, 1996 (date of original deposit) at International Patent Organism Depository, National Institute of Advanced Industrial Science and Technology, AIST Tsukuba Central 6, 1-1, Higashi 1-Chome, Tsukuba-shi, Ibaraki-ken 305-8566, Japan. under accession number FERM BP-5747 (transmitted to international depository authority under Budapest Treaty on November 15, 1996). The 16S rDNA sequence of this bacterial strain is shown in SEQ ID NO:1.

[0051] Thus, the sulfated fucan-digesting enzyme used according to the present invention can be produced by culturing a bacterium that is determined to belong to the same genus as *Fucanobacter lyticus* SN-1009 based on the 16S rDNA sequence. According to the present invention, *Alteromonas* sp. SN-1009, a spontaneous or artificial mutant of *Alteromonas* sp. SN-1009 and microorganisms belonging to genus *Alteromonas* and genus *Fucanobacter* capable of producing the sulfated fucan-digesting enzyme used according to the present invention can be utilized.

[0052] The sulfated fucan-digesting enzyme to be used according to the present invention can be obtained from the above-mentioned microorganism according to the method as described in Example 1.

[0053] The sulfated fucan oligosaccharide of the present invention can be prepared by allowing a sulfated fucan-digesting enzyme to act on a sulfated fucan-containing material. For example, a partially purified preparation of sulfated fucan, a sulfated fucose-containing polysaccharide fraction derived from a brown alga, a product obtained by extracting a brown alga with an aqueous solvent, or a brown alga itself can be preferably used as a sulfated fucan-containing material.

[0054] For preparing the sulfated fucan oligosaccharide of the present invention, a sulfated fucan or a sulfated fucan-containing material may be dissolved according to a conventional method. The sulfated fucan of the present invention or the sulfated fucan-containing material may be dissolved in the solution at the maximal concentration. However, the concentration is usually selected taking its operability and the amount of the sulfated fucan-digesting enzyme according to the present invention used in a reaction into consideration. The solvent for the sulfated fucan may be selected

from water, buffers and the like depending on the objects. Usually, the pH of the solution is nearly neutral. The enzymatic reaction is usually carried out at about 30°C. The molecular weight of the sulfated fucan oligosaccharide can be controlled by adjusting the ratio or amount of the sulfated fucan-digesting enzyme according to the present invention used in the reaction, the composition of the reaction mixture, the reaction time and the like. The sulfated fucan oligosaccharide of the present invention having more homogeneous molecular weight distribution or more homogeneous charge density distribution can be prepared by subjecting the sulfated fucan oligosaccharide of the present invention obtained as described above to molecular weight fractionation or fractionation using an anion exchange column. A conventional means for molecular weight fractionation can be applied. For example, gel filtration or molecular weight fractionation membrane may be used. Optionally, the smaller molecules may be further purified using ion-exchange resin treatment, active carbon treatment or the like, or they may be desalted, sterilized or lyophilized. Thus, the sulfated fucan oligosaccharide of the present invention having a structure so homogeneous that one can determine the structure by NMR analysis as described below can be obtained.

[0055] Although it is not intended to limit the present invention, for example, a sulfated fucan oligosaccharide having a chemical structure selected from the group consisting of general formulas (II), (III), (XIII), (XIV), (XV) and (XVI):

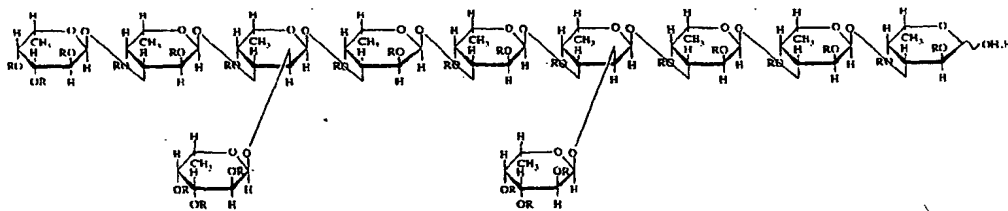
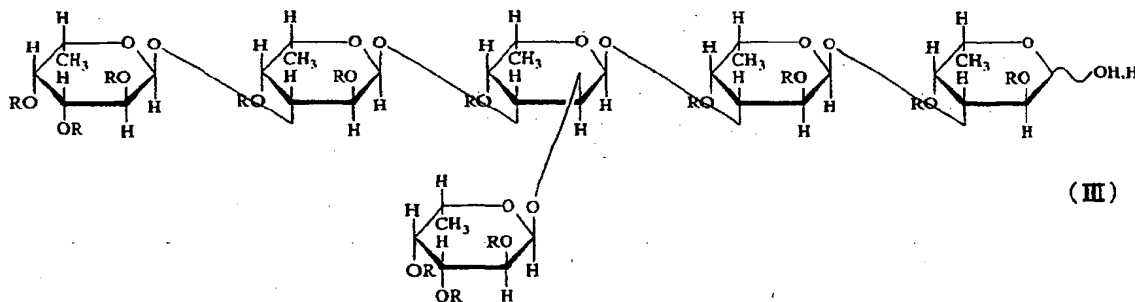
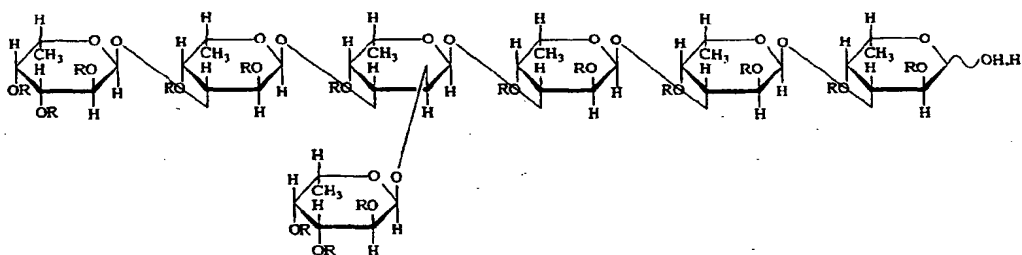

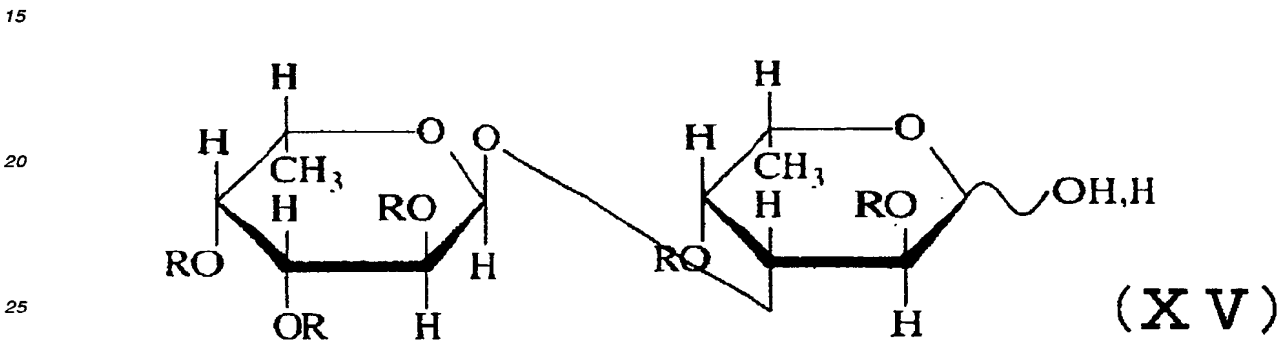
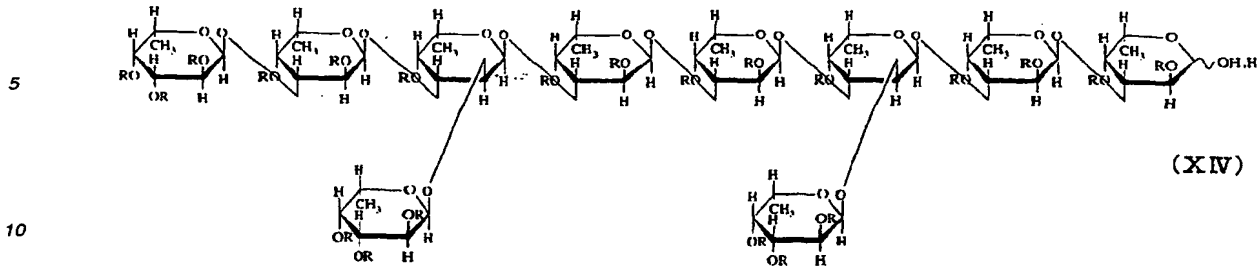

and

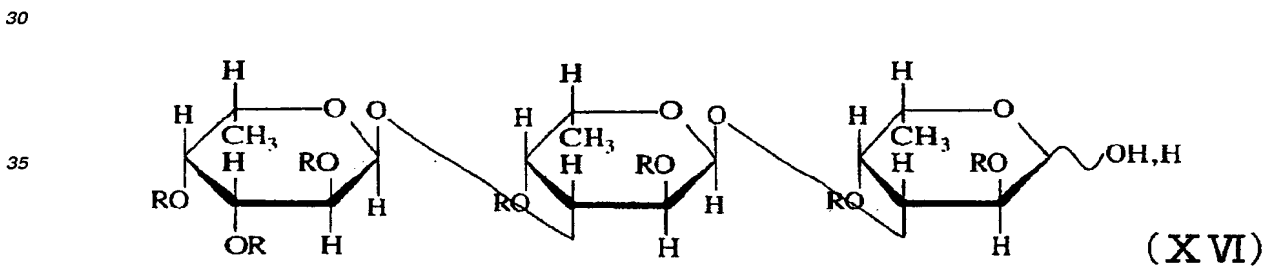

wherein R is H or SO₃H and at least one of Rs is SO₃H in all formulas above,
or a salt thereof exemplifies the sulfated fucan oligosaccharide of the present invention.

[0056] The sulfated fucan oligosaccharides of the present invention have sulfate groups within the molecules, which groups react with various bases to form salts. The sulfated fucan oligosaccharide of the present invention is stable when it is in a form of salt. It is usually provided in a form of sodium and/or potassium and/or calcium salt. The sulfated fucan oligosaccharide of the present invention in a free form can be derived from a salt thereof by utilizing cation-exchange resin such as Dowex 50W. Optionally, it can be subjected to conventional salt-exchange to convert it into any one of various desirable salts.

[0057] Pharmaceutically acceptable salts can be used as the salts of the sulfated fucan oligosaccharide of the present invention. Examples of the salts include salts with alkaline metals such as sodium and potassium and alkaline earth metals such as calcium, magnesium and zinc as well as ammonium salts.

[0058] Additionally, the sulfated fucan oligosaccharide of the present invention can be used as a reagent for glyco-technology. For example, a substance which is very useful as a reagent for glyco-technology (e.g., which can be used as a fluorescence-labeled standard for the sulfated fucan oligosaccharide) can be provided by subjecting the oligosaccharide to 2-aminopyridine (PA)-labeling according to the method as described in JP-B 5-65108 to prepare a PA-labeled oligosaccharide.

Examples

[0059] The following examples further illustrate the present invention in detail but are not to be construed to limit the scope thereof.

[0060] In the following examples, the molecular weights of the oligosaccharides of sulfated fucan are their average molecular weights that were calculated from the results of mass analyses of them.

Referential Example 1: Preparation of fucoidan from *Kjellmaniella crassifolia*

[0061] 2 kg of dried cultured *Kjellmaniella crassifolia* was disrupted using a cutter mill (Masuko Sangyo) equipped with a screen having a pore diameter of 1 mm and suspended in 20 L of 80% ethanol. The suspension was stirred at 25°C for 3 hours and filtered through a filter paper. The residue was suspended in 40 L of 30 mM phosphate buffer (pH 6.5) containing 100 mM sodium chloride. The suspension was treated at 95°C for 2 hours and filtered through a stainless steel screen having a pore diameter of 106 µm. 200 g of active carbon, 4.5 L of ethanol and 12,000 U of alginate lyase K (Nagase Biochemicals) were added to the filtrate. The mixture was stirred at 25°C for 20 hours, and then centrifuged. The supernatant was concentrated to 4 L using an ultrafiltration device equipped with hollow fibers with exclusion molecular weight of 100,000, centrifuged to remove insoluble substances and allowed to stand at 5°C for 24 hours. The formed precipitate was removed by centrifugation. The supernatant was subjected to solvent exchange for 100 mM sodium chloride using an ultrafiltration device. The solution was cooled to 4°C or below, and the pH was adjusted to 2.0 with hydrochloric acid. The formed precipitate was removed by centrifugation. The pH of the supernatant was adjusted to 8.0 with sodium hydroxide. The supernatant was concentrated to 4 L. The concentrate was subjected to solvent exchange for 20 mM sodium chloride using an ultrafiltration device. Insoluble substances in the solution were removed by centrifugation. The supernatant was then lyophilized to obtain 76 g of a dried fucoidan preparation from *Kjellmaniella crassifolia*.

Referential Example 2: Preparation of sulfated fucan fraction

[0062] 7 g of the dried fucoidan preparation as described in Referential Example 1 was dissolved in 700 ml of 20 mM imidazole-hydrochloride buffer (pH 8.0) containing 50 mM sodium chloride and 10% ethanol and centrifuged to remove insoluble substances. The supernatant was loaded onto a DEAE-Cellulofine A-800 column (11.4 x 48 cm) equilibrated with the same buffer. After washing with the same buffer, elution was then carried out with a gradient of 50 mM to 1.95 M sodium chloride. Each fraction contained 250 ml of the eluate. The total sugar content and the uronic acid content of each fraction were measured according to the phenol-sulfuric acid method and the carbazole-sulfuric acid method, respectively. The fractions 43-49, 50-55 and 56-67 were combined, desalted by electro dialysis and lyophilized. 340 mg, 870 mg and 2.64 g of dried products were obtained from the fractions 43-49, 50-55 and 56-67, respectively. The fraction obtained from the fractions 56-67 was used as a sulfated fucan fraction.

Referential Example 3: Method for measuring activity of sulfated fucan-digesting enzyme

[0063] 12 µl of a 2.5% solution of the sulfated fucan fraction, 60 µl of 50 mM imidazole-hydrochloride buffer (pH 7.5), 9 µl of 4 M sodium chloride, 6 µl of 1 M calcium chloride, 21 µl of water and 12 µl of a solution of the sulfated fucan-digesting enzyme according to the present invention were mixed together. After reacting at 30°C for 3 hours, the reaction mixture was treated at 100°C for 10 minutes. After centrifugation, 100 µl of the supernatant was analyzed using HPLC to determine the degree of conversion into smaller molecules. As controls, a reaction mixture obtained by a reaction in which the buffer used for dissolving the sulfated fucan-digesting enzyme solution was used in place of the digesting enzyme solution and a reaction mixture obtained by a reaction in which water was used in place of the sulfated fucan fraction were similarly analyzed using HPLC.

[0064] One unit of an activity of sulfated fucan-digesting enzyme is defined as an amount of an enzyme that cleaves fucosyl bonds in 1 µmol of a sulfated fucan in 1 minute in the above-mentioned reaction system. The activity of sulfated fucan-digesting enzyme was calculated according to the following equation:

$$\{(12 \times 1000 \times 2.5 / 100) \text{MG}\} \times \{(\text{MG} / \text{M}) - 1\} \times \{ 1 / (180 \times 0.012) \} = \text{U/ml}$$

12x1000x2.5/100: sulfated fucan fraction added (µg);

MG: the average molecular weight of the sulfated fucan as a substrate;

M: the average molecular weight of the reaction product;

(MG/M)-1: the number of sites cleaved by the enzyme in one sulfated fucan molecule;

180: the reaction time (minutes); and
0.012: the volume of the enzyme solution (ml).

[0065] The HPLC was carried out as follows:

Instrument: L-6200 (Hitachi);
Column: OHpak SB-806HQ (8 x 300 mm; Showa Denko);
Eluent : 50 mM sodium chloride containing 5 mM sodium azide;
Detection: differential refractive index detector (Shodex RI-71, Showa Denko);
Flow rate: 1 ml/minute; and
Column temperature: 25°C.

[0066] The following procedure was carried out in order to determine the average molecular weight of the reaction product. Commercially available pullulan (STANDARD P-82, Showa Denko) of which the molecular weight was known was analyzed under the same conditions as those for the above-mentioned HPLC analysis. The relationship between the molecular weight of pullulan and retention time was expressed as a curve, which was used as a standard curve for determining the molecular weight of the reaction product. The amount of protein was determined by measuring the absorbance of the enzyme solution at 280 nm. The calculation was carried out assuming the absorbance of a solution containing a protein at a concentration of 1 mg/ml as 1.0.

Example 1: Preparation of sulfated fucan-digesting enzyme

[0067] *Fucanobacter lyticus* SN-1009 was inoculated into 4 ml of a medium consisting of artificial seawater (Jamarine Laboratory) (pH 8.2) containing 0.2% fucoidan prepared as described in Referential Example 1 and 0.3% peptone which had been autoclaved at 120°C for 20 minutes, and cultured at 25°C for 24 hours to prepare a seed culture. The seed culture was inoculated into 600 ml of a medium consisting of artificial seawater (pH 8.2) containing 0.25% glucose, 1% peptone, 0.05% yeast extract and antifoaming agent (KM70, Shin-Etsu Chemical) in a 2-L Erlenmeyer flask which had been autoclaved at 120°C for 20 minutes, and cultured at 25°C for 20 hours. 20 L of a medium consisting of artificial seawater (pH 8.2) containing 1% peptone, 0.02% yeast extract and antifoaming agent (KM70, Shin-Etsu Chemical) in a 30-L jar fermentor which had been autoclaved at 120°C for 20 minutes was mixed with the fucoidan prepared as described in Referential Example 1 which had been treated at 100°C for 20 minutes. The culture was inoculated into the mixture and cultured at 25°C for 28 hours. After cultivation, the culture was centrifuged to collect cells and a culture supernatant.

[0068] The culture supernatant was concentrated using an ultrafiltration device equipped with hollow fibers with exclusion molecular weight of 10,000. The concentrate was subjected to solvent exchange for 20 mM Tris-hydrochloride buffer (pH 8.2) containing 10 mM calcium chloride and 150 mM sodium chloride and centrifuged to obtain a supernatant.

[0069] The supernatant was loaded onto a 2-L DEAE-Cellulofine A-800 column equilibrated with the same buffer. After washing with the same buffer, elution was then carried out with a gradient of 150 mM to 400 mM sodium chloride such that each fraction contained 63 ml of the eluate to collect an active fraction.

[0070] The active fraction was concentrated using an ultrafiltration device equipped with hollow fibers with exclusion molecular weight of 10,000. The concentrate was subjected to solvent exchange for 20 mM Tris-hydrochloride buffer (pH 8.2) containing 10 mM calcium chloride and 100 mM sodium chloride. The enzyme solution was loaded onto a 200-ml DEAE-Cellulofine A-800 column equilibrated with the same buffer. After washing with the same buffer, elution was then carried out with a gradient of 100 mM to 300 mM sodium chloride such that each fraction contained 19 ml of the eluate to collect an active fraction.

[0071] The active fraction was concentrated using an ultrafiltration device equipped with an ultrafiltration membrane with exclusion molecular weight of 10,000. Sodium chloride at a final concentration of 4 M was added thereto. The solution was loaded onto a Phenyl-Sepharose CL-4B column equilibrated with 20 mM Tris-hydrochloride buffer (pH 8.0) containing 100 mM calcium chloride and 4 M sodium chloride. After washing with the same buffer, elution was then carried out with a gradient of 4 M to 1 M sodium chloride such that each fraction contained 9.4 ml of the eluate. Thus, a purified preparation of sulfated fucan-digesting enzyme was obtained.

Example 2: Preparation of sulfated fucan oligosaccharide using sulfated fucan-digesting enzyme, and purification and structural analysis thereof

(1) Preparation

[0072] 200 g of dried cultured *Kjellmaniella crassifolia* was soaked in 10 L of 18 mM imidazole-hydrochloride buffer

(pH 7.0) containing 45 mM calcium chloride, 500 mM sodium chloride and 9% ethanol. 30 U of the sulfated fucan-digesting enzyme was added thereto. The mixture was stirred at room temperature for 2 days and filtered through a filter paper. A small molecule fraction recovered from the filtrate using an ultrafiltration device equipped with hollow fibers with exclusion molecular weight of 100,000 was designated as a sulfated fucan oligosaccharide fraction 1.

(2) Purification

[0073] The sulfated fucan oligosaccharide fraction 1 obtained in Example 2-(1) was desalted using a desalting apparatus (Micro Acilyzer G3, Asahi Kasei) and concentrated using a rotary evaporator. Imidazole and sodium chloride were added to the sulfated fucan oligosaccharide solution 1 at final concentrations of 10 mM and 300 mM, respectively. The resulting mixture was loaded onto a 1-L DEAE-Cellulofine A-800 column equilibrated with 10 mM imidazole-hydrochloride buffer (pH 6.0) containing 300 mM sodium chloride. After adequately washing with the same buffer, elution was then carried out with a gradient of 300 mM to 1200 mM sodium chloride. The total sugar content and the total uronic acid content of each of the eluted fractions were measured according to the phenol-sulfuric acid method and the carbazole-sulfuric acid method, respectively. As a result, the eluted fractions formed at least four distinct peaks. The fractions in the respective peaks were subjected to mass spectrometric analyses. Determination of the saccharide compositions for the respective peaks showed that they contained only fucose but did not contain uronic acid. Compositions of the oligosaccharides having the respective masses estimated based on the saccharide compositions are shown in Table 1.

Table 1

Peak no.	Molecular weight	Composition of oligosaccharide		
		Fucose	Sulfate group	Sodium
1-(1)	1914	6	10	10
	1812	6	9	9
	1564	5	8	8
1-(2)	2264	7	12	12
	2162	7	11	11
	1914	6	10	10
	2016	6	11	11
1-(3)	2366	7	13	13
	2264	7	12	12
	2016	6	11	11
	1914	6	10	10
	2162	7	11	11
1-(4)	3460	11	18	18
	3358	11	17	17
	3110	10	16	16

[0074] The fractions constituting each peak were combined, concentrated using an evaporator and purified as follows:

Column: YMC Pack Polyamine II (20 x 250 mm, YMC);

Flow rate: 8 ml/minute;

Column temperature: 30°C;

Equilibration solution: 0.5 M sodium dihydrogenphosphate containing 10% acetonitrile;

Elution solution: gradient from 0.5 M sodium dihydrogenphosphate containing 10% acetonitrile to 1.5 M sodium dihydrogenphosphate containing 10% acetonitrile; as for peak number 1-(4), the gradient for the elution was from 787.5 mM sodium dihydrogenphosphate containing 10% acetonitrile to 1462.5 mM sodium dihydrogenphosphate containing 10% acetonitrile;

Fractionation: 4 ml/fraction; and
 Detection: the phenol-sulfuric acid method.

[0075] Fractions obtained by the column chromatography were subjected to mass spectrometric analyses. As a result, substances having masses of 1914, 2264, 2366 and 3460 were observed as main peaks for the peak nos. 1-(1), 1-(2), 1-(3) and 1-(4), respectively. Fractions constituting each peak were combined, loaded onto a Cellulofine GCL-25 column equilibrated with 10% ethanol and eluted using 10% ethanol for desalting. Thus, the sulfated fucan oligosaccharides 1-(1) to 1-(4) of the present invention were obtained.

(3) Structural analysis

[0076] The sulfated fucan oligosaccharides 1-(1) to 1-(4) of the present invention obtained in Example 2-(2) were subjected to analyses of saccharides at the reducing ends and saccharide compositions according to a fluorescence labeling method using 2-aminopyridine. As a result, the saccharide at the reducing end of and the sole saccharide constituting each of the oligosaccharides 1-(1) to 1-(4) were determined to be fucose. Next, determination of the sulfuric acid content (measured according to the turbidimetric method using barium chloride) and the uronic acid content (measured according to the carbazole-sulfuric acid method), and NMR analysis using a nuclear magnetic resonance apparatus JNM α -500 (Nippon Denshi) were carried out. Samples to be analyzed were subjected to structural analyses after exchange for heavy water according to a conventional method. Bonds of constituting saccharides were analyzed using the HMBC method, a method for ^1H -detection of heteronuclei. The DQF-COSY method and the HOHAHA method were used for identification in ^1H -NMR. The HSQC method was used for identification in ^{13}C -NMR.

[0077] Physical properties of the oligosaccharides 1-(1) to 1-(4) are shown below.

(a) Physical properties of the oligosaccharide 1-(1)

[0078] The results for mass spectrometric analysis and identification in NMR analysis are shown below. The ^1H -NMR spectrum, ^{13}C -NMR spectrum and mass spectrum of the sulfated fucan oligosaccharide 1-(1) of the present invention are illustrated in Figures 1, 2 and 3, respectively. In Figures 1 and 2, the vertical axes represent the signal intensity and the horizontal axes represent the chemical shift value (ppm). In Figure 3, the vertical axis represents the relative intensity and the horizontal axis represents the m/z value.

Molecular weight: 1914

MS m/z 455.0 $[\text{M}-4\text{Na}]^4+$, 614.8 $[\text{M}-3\text{Na}]^3+$, 933.8 $[\text{M}-2\text{Na}]^2+$

[0079] Results of ^1H -NMR and ^{13}C -NMR analyses are shown in Tables 2 and 3.

Table 2

	Chemical shift value (ppm)	
	^{13}C -NMR	^1H -NMR Chemical shift value, multiplicity, coupling constant
F1-1	91.3	5.41, d, 3.4
F1-2	75.9	4.39, dd, 3.4, 10.1
F1-3	75.9	4.14, dd, 2.4, 10.1
F1-4	81.1	4.81, d, 2.4
F1-5	67.6	4.20, q, 6.4
F1-6	16.8	1.16, d, 6.4
F2-1	99.7	5.25, d, 1.8
F2-2	75.2	4.43, m
F2-3	72.5	4.43, m
F2-4	78.8	4.75, br-s
F2-5	68.3	4.27, q, 6.7
F2-6	17.0	1.18, d, 6.7
F3-1	91.0	5.22, br-s

EP 1 306 389 A2

Table 2 (continued)

	Chemical shift value (ppm)	
	¹³ C-NMR	¹ H-NMR Chemical shift value, multiplicity, coupling constant
F3-2	75.8	4.10, d, 5.2
F3-3	74.7	4.27, dd, 5.2, 2.5
F3-4	74.0	4.73, dd, 2.5, 5.5
F3-5	71.9	4.32, m, 5.5, 6.1
F3-6	14.2	1.45, d, 6.1

Table 3

	Chemical shift value (ppm)	
	¹³ C-NMR	¹ H-NMR Chemical shift value, multiplicity, coupling constant
F4-1	98.5	5.32, d, 3.1
F4-2	74.0	4.45, m
F4-3	71.0	4.27, m
F4-4	78.9	4.76, br-s
F4-5	68.3	4.29, q, 6.7
F4-6	17.0	1.18, d, 6.7
F5-1	96.1	5.29, d, 3.4
F5-2	75.9	4.35, dd, 3.4, 10.7
F5-3	67.4	4.27, dd, 2.4, 10.7
F5-4	82.3	4.60, d, 2.4
F5-5	67.4	4.38, q, 6.4
F5-6	17.0	1.16, d, 6.4
F6-1	100.5	5.18, d, 4.0
F6-2	66.7	3.84, dd, 4.0, 10.4
F6-3	78.8	4.45, dd, 3.1, 10.4
F6-4	71.1	4.07, d, 3.1
F6-5	67.9	4.06, q, 6.4
F6-6	16.5	1.13, d, 6.4

Saccharide composition: L-fucose (6 molecules)

Sulfate group: 10 molecules

Sodium: 10 molecules

[0080] The numbers for peak identification in ¹H-NMR and ¹³C-NMR are as indicated in formula (IV) below:

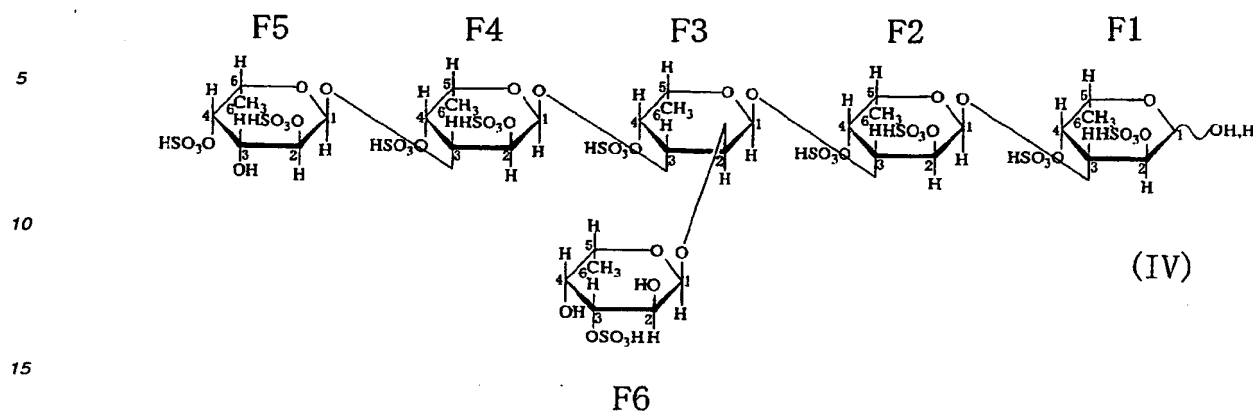

(b) Physical properties of the oligosaccharide 1-(2)

[0081] The results for mass spectrometric analysis and identification in NMR analysis are shown below. The $^1\text{H-NMR}$ spectrum, $^{13}\text{C-NMR}$ spectrum and mass spectrum of the sulfated fucan oligosaccharide 1-(2) of the present invention are illustrated in Figures 4, 5 and 6, respectively. In Figures 4 and 5, the vertical axes represent the signal intensity and the horizontal axes represent the chemical shift value (ppm). In Figure 6, the vertical axis represents the relative intensity and the horizontal axis represents the m/z value.

Molecular weight: 2264

MS m/z 354.2 $[\text{M}-6\text{Na}^+]^6-$, 429.8 $[\text{M}-5\text{Na}^+]^5-$, 543.0 $[\text{M}-4\text{Na}^+]^4-$, 731.6 $[\text{M}-3\text{Na}^+]^3-$

[0082] Results of $^1\text{H-NMR}$ and $^{13}\text{C-NMR}$ analyses are shown in Tables 4 and 5.

Table 4

	Chemical shift value (ppm)	
	$^{13}\text{C-NMR}$	$^1\text{H-NMR}$
F1-1	90.3	5.41, d, 3.4
F1-2	75.7	4.38, dd, 3.4, 9.8
F1-3	74.9	4.22, m
F1-4	80.2	4.80, br-s
F1-5	67.5	4.23, q, 6.7
F1-6	16.0	1.19, d, 6.7
F2-1	99.3	5.31, d, 3.4
F2-2	75.2	4.40, m
F2-3	76.9	4.29, m
F2-4	81.5	4.83, d, 2.8
F2-5	68.5	4.22, q, 6.4
F2-6	16.4	1.16, d, 6.4
F3-1	99.7	5.29, br-s
F3-2	74.0	4.41, m
F3-3	71.1	4.41, m
F3-4	78.2	4.75, m
F3-5	67.4	4.34, q, 6.7

EP 1 306 389 A2

Table 4 (continued)

	Chemical shift value (ppm)	
	¹³ C-NMR	¹ H-NMR
F3-6	16.5	1.22, d, 6.7
F4-1	89.6	5.26, br-s
F4-2	74.4	4.07, m
F4-3	74.4	4.27, m
F4-4	73.3	4.73, dd, 2.8, 5.8
F4-5	71.2	4.36, m, 5.8, 6.4
F4-6	13.5	1.44, d, 6.4

Table 5

	Chemical shift value (ppm)	
	¹³ C-NMR	¹ H-NMR
F5-1	98.3	5.31, d, 3.4
F5-2	73.4	4.45, dd, 3.4, 10.1
F5-3	70.4	4.26, m
F5-4	78.2	4.76, br-s
F5-5	67.6	4.33, q, 6.4
F5-6	16.4	1.23, d, 6.4
F6-1	95.2	5.29, d, 3.7
F6-2	75.2	4.36, m
F6-3	66.8	4.27, m
F6-4	81.7	4.60, d, 2.8
F6-5	66.8	4.38, q, 6.7
F6-6	16.4	1.16, d, 6.7
F7-1	100.1	5.17, d, 4.3
F7-2	66.1	3.86, dd, 4.3, 10.4
F7-3	78.3	4.45, dd, 3.7, 10.4
F7-4	70.5	4.07, d, 3.7
F7-5	67.4	4.05, q, 6.4
F7-6	16.0	1.13, d, 6.4

Saccharide composition: L-fucose (7 molecules)

Sulfate group: 12 molecules

Sodium: 12 molecules

[0083] The numbers for peak identification in ¹H-NMR and ¹³C-NMR are as indicated in formula (V) below:

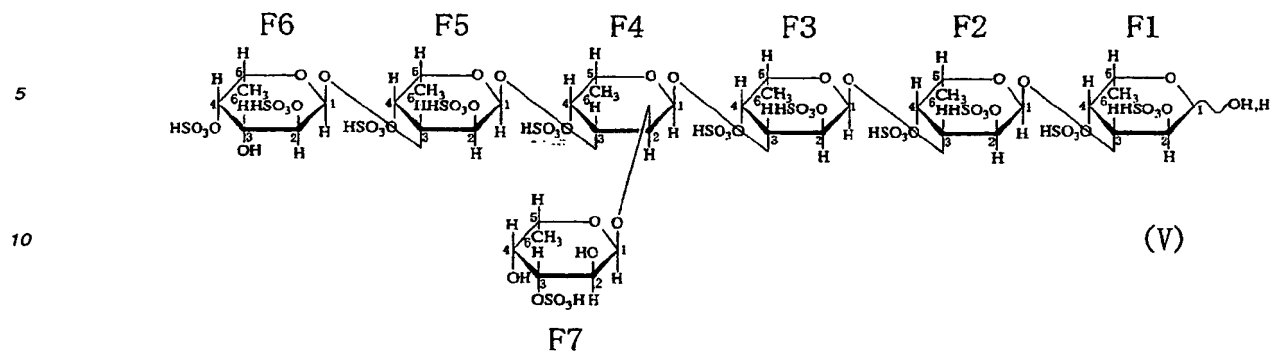

[0084] An activity of inducing HGF production as determined according to the method described in Example 1-(2) in WO 00/62785 was observed for the sulfated saccharide of formula (V).

20 (c) Physical properties of the oligosaccharide 1-(3)

[0085] The results for mass spectrometric analysis are shown below. The $^1\text{H-NMR}$ spectrum, $^{13}\text{C-NMR}$ spectrum and mass spectrum of the sulfated fucan oligosaccharide 1-(3) of the present invention are illustrated in Figures 7, 8 and 9. In Figures 7 and 8, the vertical axes represent the signal intensity and the horizontal axes represent the chemical shift value (ppm) In Figure 9, the vertical axis represents the relative intensity and the horizontal axis represents the m/z value.

Molecular weight: 2366

MS m/z 371.4 $[\text{M}-6\text{Na}^+]^6-$, 450.3 $[\text{M}-5\text{Na}^+]^5-$, 568.6 $[\text{M}-4\text{Na}^+]^4-$, 765.7 $[\text{M}-3\text{Na}^+]^3-$

[0086] The results of $^1\text{H-NMR}$ and $^{13}\text{C-NMR}$ analyses are shown in Tables 6 and 7.

Table 6

	Chemical shift value (ppm)	
	$^{13}\text{C-NMR}$	$^1\text{H-NMR}$ Chemical shift value, multiplicity, coupling constant
F1-1	89.6	5.42, d, 2.5
F1-2	75.3	4.40, m
F1-3	73.9	4.28, m
F1-4	78.6	4.78, m
F1-5	67.5	4.24, m
F1-6	15.9	1.24, d, 6.5
F2-1	98.3	5.34, d, 3.5
F2-2	74.8	4.43, m
F2-3	76.0	4.29, m
F2-4	80.8	4.83, m
F2-5	68.1	4.20, m
F2-6	15.9	1.18, d, 7.0
F3-1	99.1	5.29, m
F3-2	73.8	4.45, m
F3-3	70.8	4.45, m

EP 1 306 389 A2

Table 6 (continued)

	Chemical shift value (ppm)	
	¹³ C-NMR	¹ H-NMR Chemical shift value, multiplicity, coupling constant
F3-4	77.5	4.73, m
F3-5	66.8	4.31, m
F3-6	15.9	1.25, d, 6.5

Table 7

	Chemical shift value (ppm)	
	¹³ C-NMR	¹ H-NMR Chemical shift value, multiplicity, coupling constant
F4-1	89.2	5.27, br-s
F4-2	74.1	4.09, d, 9.5
F4-3	74.3	4.26, m
F4-4	72.8	4.74, m
F4-5	70.8	4.36, m
F4-6	13.3	1.46, d, 7.0
F5-1	97.3	5.31, d, 3.5
F5-2	73.1	4.47, dd, 10.0, 3.5
F5-3	69.8	4.27, m
F5-4	77.5	4.75, m
F5-5	67.0	4.34, m
F5-6	15.9	1.20, d, 6.0
F6-1	94.6	5.29, m
F6-2	74.9	4.38, m
F6-3	66.6	4.29, m
F6-4	81.3	4.60, m
F6-5	66.4	4.38, m
F6-6	15.4	1.17, d, 6.5
F7-1	99.3	5.22, d, 4.0
F7-2	65.9	3.91, dd, 11.0, 4.0
F7-3	75.3	4.52, dd, 11.0, 3.0
F7-4	79.0	4.80, d, 3.0
F7-5	66.6	4.16, m
F7-6	15.9	1.20, d, 6.0

Saccharide composition: L-fucose (7 molecules)

Sulfate group: 13 molecules

Sodium: 13 molecules

[0087] The numbers for signal assignment in ¹H-NMR and ¹³C-NMR are as indicated in formula (VI) below:

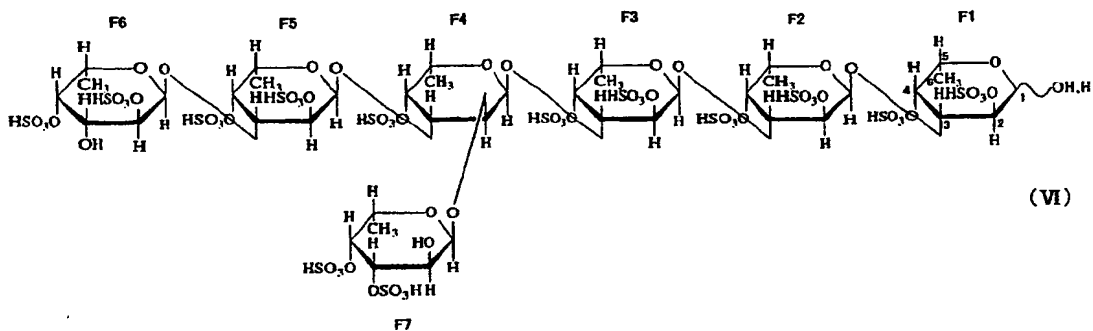

(d) Physical properties of the oligosaccharide 1-(4)

[0088] The results for mass spectrometric analysis are shown below. The ¹H-NMR spectrum, ¹³C-NMR spectrum and mass spectrum of the sulfated fucan oligosaccharide 1-(4) of the present invention are illustrated in Figures 10, 11 and 12. In Figures 10 and 11, the vertical axes represent the signal intensity and the horizontal axes represent the chemical shift value (ppm). In Figure 12, the vertical axis represents the relative intensity and the horizontal axis represents the m/z value.

Molecular weight: 3460

MS m/z 409.6 [M-8Na⁺]⁸⁻, 471.4 [M-7Na⁺]⁷⁻, 553.8 [M-6Na⁺]⁶⁻, 669.3 [M-5Na⁺]⁵⁻, 842.3 [M-4Na⁺]⁴⁻, 1130.8 [M-3Na⁺]³⁻

[0089] The results of ¹H-NMR and ¹³C-NMR analyses are shown in Tables 8 to 10.

Table 8

	Chemical shift value (ppm)	
	¹³ C-NMR	¹ H-NMR Chemical shift value, multiplicity, coupling constant
F1-1	90.3	5.39, d, 3.3
F1-2	75.5	4.37, m
F1-3	76.0	4.21, m
F1-4	79.8	4.77, m
F1-5	67.5	4.19, m
F1-6	16.5	1.15, m
F2-1	99.8	5.28, m
F2-2	73.6	4.41, m
F2-3	73.6	4.41, m
F2-4	78.1	4.74, m
F2-5	68.7	4.25, m
F2-6	16.8	1.20, m
F3-1	98.7	5.31, m
F3-2	74.8	4.46, m
F3-3	73.6	4.35, m
F3-4	78.1	4.74, m
F3-5	67.7	4.25, m
F3-6	16.8	1.20, m

Table 8 (continued)

	Chemical shift value (ppm)	
	¹³ C-NMR	¹ H-NMR Chemical shift value, multiplicity, coupling constant
F4-1	90.2	5.29, m
F4-2	74.8	4.04, m
F4-3	74.9	4.27, m
F4-4	74.3	4.74, m
F4-5	68.1	4.27, q, 6.5
F4-6	14.0	1.39, d, 6.5

Table 9

	Chemical shift value (ppm)	
	¹³ C-NMR	¹ H-NMR Chemical shift value, multiplicity, coupling constant
F5-1	99.2	5.34, d, 3.5
F5-2	74.3	4.42, m
F5-3	74.3	4.21, m
F5-4	81.5	4.81, m
F5-5	68.7	4.20, m
F5-6	16.6	1.18, m
F6-1	98.7	5.31, m
F6-2	75.3	4.46, m
F6-3	71.1	4.35, m
F6-4	78.1	4.74, m
F6-5	67.7	4.25, m
F6-6	16.7	1.19, m
F7-1	90.2	5.29, m
F7-2	74.8	4.04, m
F7-3	74.9	4.27, m
F7-4	74.3	4.74, m
F7-5	67.9	4.27, q, 7.0
F7-6	14.0	1.43, d, 7.0

Table 10

	Chemical shift value (ppm)	
	¹³ C-NMR	¹ H-NMR Chemical shift value, multiplicity, coupling constant
F8-1	96.0	5.30, m
F8-2	75.3	4.46, m
F8-3	71.1	4.35, m

Table 10 (continued)

	Chemical shift value (ppm)		
	¹³ C-NMR	¹ H-NMR Chemical shift value, multiplicity, coupling constant	
5	F8-4	78.1	4.81, m
	F8-5	67.1	4.43, m
	F8-6	16.7	1.19, m
10	F9-1	96.0	5.29, m
	F9-2	75.5	4.33, m
	F9-3	67.1	4.27, m
	F9-4	82.0	4.58, d, 2.8
15	F9-5	67.1	4.34, q, 6.5
	F9-6	16.5	1.15, d, 6.5
	F10-1	99.8	5.19, d, 4.2
20	F10-2	66.3	3.85, dd, 4.2, 10.4
	F10-3	78.5	4.43, m
	F10-4	70.8	4.05, br-s
	F10-5	67.5	4.03, q, 6.6
25	F10-6	16.1	1.12, d, 6.6
	F11-1	99.8	5.21, d, 4.2
	F11-2	66.3	3.85, dd, 4.2, 10.4
30	F11-3	78.5	4.44, m
	F11-4	70.8	4.06, br-s
	F11-5	67.5	4.08, q, 6.6
35	F11-6	16.1	1.12, d, 6.6

Saccharide composition: L-fucose (11 molecules)

Sulfate group: 18 molecules

Sodium: 18 molecules

[0090] The numbers for signal assignment in ¹H-NMR and ¹³C-NMR are as indicated in formula (VII) below:

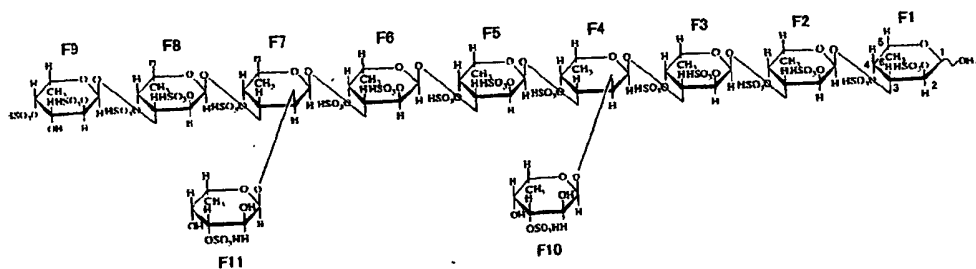

(VII)

55

Example 3: Preparation of sulfated fucan oligosaccharide using sulfated fucan-digesting enzyme, and purification and structural analysis thereof

(1) Preparation

[0091] Chips were prepared from dried cultured *Kjellmaniella crassifolia* using a cutter mill (Masuko Sangyo) equipped with a screen having a pore diameter of 1 mm. 250 g of the *Kjellmaniella crassifolia* chips were suspended in 5 L of 80% ethanol. The suspension was stirred at room temperature for 2 hours and filtered. The washing in 80% ethanol was repeated four times to obtain washed *Kjellmaniella crassifolia* chips. 250 g of the washed chips were suspended in 5 L of 17 mM imidazole-hydrochloride buffer (pH 7.5) containing 125 mM calcium chloride, 250 mM sodium chloride and 10% ethanol. The suspension was stirred at room temperature for 24 hours, filtered and centrifuged to obtain a *Kjellmaniella crassifolia* fucoidan solution. 10 U of the sulfated fucan-digesting enzyme was added to 1 L of the extract. The resulting mixture was stirred at room temperature for three days, and then filtered through a filter paper. A supernatant was obtained by centrifuging the filtrate. A small molecule fraction recovered from the supernatant using an ultrafiltration device equipped with hollow fibers with exclusion molecular weight of 10,000 was designated as a sulfated fucan oligosaccharide fraction 2.

(2) Purification

[0092] The sulfated fucan oligosaccharide fraction 2 obtained in Example 3-(1) was loaded onto a 1-L DEAE-Cellulofine A-800 column equilibrated with 10 mM imidazole-hydrochloride buffer (pH 6.5) containing 100 mM sodium chloride. After adequately washing with the same buffer, elution was then carried out with a gradient of 100 mM to 1 M sodium chloride. The total sugar content and the total uronic acid content of each of the eluted fractions were measured according to the phenol-sulfuric acid method and the carbazole-sulfuric acid method, respectively. As a result, the eluted fractions formed two peaks. The fractions in the respective peaks were subjected to mass spectrometric analyses. Determination of the saccharide compositions for the respective peaks showed that they contained only fucose but did not contain uronic acid. Compositions of the oligosaccharides having the respective masses estimated based on the saccharide compositions are shown in Table 11.

Table 11

Peak no.	Molecular weight	Composition of oligosaccharide		
		Fucose	Sulfate group	Sodium
2-(1)	1914	6	10	10
	2264	7	12	12
	2016	6	11	11
2-(2)	3110	10	16	16
	2760	9	14	14
	3360	11	17	17
	4308	14	22	22
	3958	13	20	20

[0093] The fractions constituting each peak were pooled, concentrated using an evaporator, and purified by the same method described in Example 2-(2).

[0094] Fractions obtained by YMC Pack Polyamine II column chromatography were subjected to mass spectrometric analyses, and substances having masses of 1914 and 2016 from peak number 2-(1), and a substance having a mass of 3110 from peak number 2-(2) were obtained as their main peaks.

[0095] The fractions constituting each peak that contained substances having masses of 1914, 2016, and 3110 were pooled, applied to a Cellulofine GCL-25 column equilibrated with 10% ethanol and eluted using 10% ethanol to desalt. Thus the sulfated fucan oligosaccharides 2-(1)-1, 2-(1)-2, and 2-(2) of the present invention were obtained.

(3) Structural analyses

[0096] The sulfated fucan oligosaccharides 2-(1)-1, 2-(1)-2, and 2-(2) of the present invention obtained in Example

3-(2) were subjected to analyses of the reducing terminal sugar and component sugar according to a fluorescence labeling method using 2-aminopyridine. As a result, the reducing terminal and the component sugar of them were only fucose. Next, their sulfate content (by the turbidimetric method using barium chloride) and their uronic acid content (by the carbazole-sulfuric acid method) were determined. NMR analyses of them using a nuclear magnetic resonance apparatus JNM α -500 (Nippon Denshi) were also carried out. The linkages among the constituting saccharides were analyzed using the HMBC method, a method for ^1H -detection of heteronuclei. The DQF-COSY method and the HO-HAHA method were used for the assignment of ^1H -NMR data, and the HSQC method was used for the assignment of ^{13}C -NMR data.

[0097] Physical properties of the sulfated fucan oligosaccharides 2-(1)-1, 2-(1)-2, and 2-(2) of the present invention are shown below.

(a) Physical properties of the sulfated fucan oligosaccharide 2-(1)-1

[0098] The result of all the above analyses showed that the sulfated fucan oligosaccharide 2-(1)-1 is the same substance as the sulfated fucan oligosaccharide 1-(1) of the present invention.

(b) Physical properties of the sulfated fucan oligosaccharide 2-(1)-2

[0099] The results for the mass spectrometric analysis and assignment in NMR analyses are shown below. The ^1H -NMR spectrum, ^{13}C -NMR spectrum, and the mass spectrum of this oligosaccharide are shown in Figures 13, 14, and 15, respectively. In Figures 13 and 14, the vertical axes represent the signal intensity and the horizontal axes represent the chemical shift value (ppm). In Figure 15, the vertical axis represents the relative intensity of the signals and the horizontal axis represents the m/z value.

Molecular weight: 2016

MS m/z 313.1 $[\text{M}-6\text{Na}]^6$, 380.3 $[\text{M}-5\text{Na}]^5$, 481.1 $[\text{M}-4\text{Na}]^4$, 649.1 $[\text{M}-3\text{Na}]^3$, 985.0 $[\text{M}-2\text{Na}]^2$

[0100] The results of ^1H -NMR and ^{13}C -NMR analyses are shown in Tables 12 and 13.

Table 12

	Chemical shift value (ppm)	
	^{13}C -NMR	^1H -NMR Chemical shift value, multiplicity, coupling constant
F1-1	90.7	5.43, d, 3.6
F1-2	75.3	4.41, dd, 3.6, 10.1
F1-3	75.7	4.15, dd, 10.1, 2.4
F1-4	80.6	4.83, d, 2.4
F1-5	67.0	4.22, q, 6.6
F1-6	16.5	1.18, d, 6.6
F2-1	99.2	5.27, d, 3.2
F2-2	74.5	4.45, m
F2-3	71.9	4.46, m
F2-4	78.1	4.77, br-s
F2-5	67.7	4.30, q, 6.6
F2-6	16.5	1.20, d, 6.6
F3-1	89.8	5.24, br-s
F3-2	75.2	4.12, m
F3-3	74.2	4.28, m
F3-4	73.3	4.76, br-s
F3-5	71.4	4.36, q, 6.0
F3-6	13.6	1.48, d, 6.0

Table 13

	Chemical shift value (ppm)	
	¹³ C-NMR	¹ H-NMR Chemical shift value, multiplicity, coupling constant
F4-1	98.2	5.33, d, 3.3
F4-2	73.3	4.47, m
F4-3	71.0	4.28, m
F4-4	78.1	4.78, br-s
F4-5	67.7	4.32, q, 6.6
F4-6	16.5	1.20, d, 6.6
F5-1	94.8	5.31, d, 3.4
F5-2	75.3	4.38, m
F5-3	66.9	4.28, m
F5-4	81.7	4.62, d, 2.4
F5-5	66.8	4.40, q, 6.6
F5-6	16.5	1.18, d, 6.6
F6-1	100.1	5.22, d, 3.6
F6-2	66.3	3.89, dd, 3.6, 10.4
F6-3	75.7	4.52, dd, 10.4, 3.0
F6-4	79.2	4.82, d, 3.0
F6-5	67.2	4.18, q, 6.6
F6-6	16.3	1.20, d, 6.6

Component sugar: only L-fucose (6 molecules)

Sulfate residues: 11 molecules

Sodium: 11 molecules

[0101] The numbers for signal assignment in ¹H-NMR and ¹³C-NMR analyses are as indicated in formula (VIII) below:

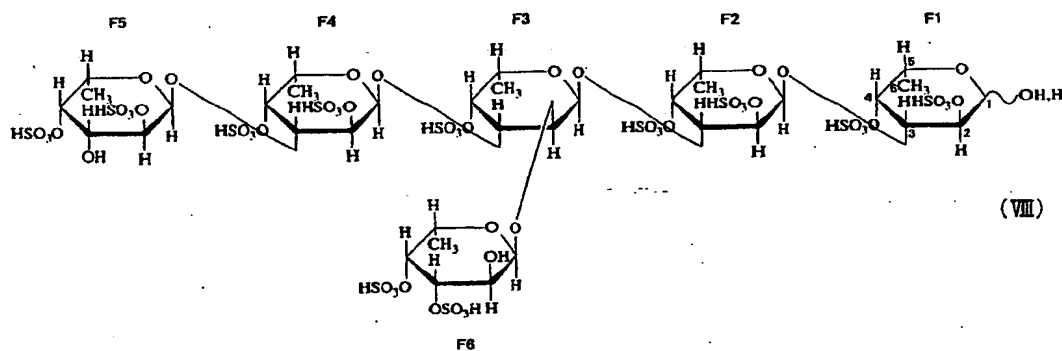

Physical properties of the oligosaccharide 2-(2)

[0102] The results of the mass spectrometric analysis are shown below, and the ¹H-NMR spectrum, ¹³C-NMR spectrum, and the mass spectrum of the sulfated fucan oligosaccharide 2-(2) of the present invention are shown in Figures 16, 17, and 18, respectively. In Figures 16 and 17, the vertical axes represent the signal intensity and the horizontal

axes represent the chemical shift value (ppm). In Figure 18, the vertical axis represents the relative intensity of the signals and the horizontal axis represents the m/z value.

Molecular weight: 3111

MS m/z 365.8[M-8Na+]⁸⁻, 421.4[M-7Na+]⁷⁻, 495.2[M-6Na+]⁶⁻, 599.1[M-5Na+]⁵⁻, 755.0[M-4Na+]⁴⁻, 1013.7[M-3Na+]³⁻

5 [0103] The results of ¹H-NMR and ¹³C-NMR analyses are shown in Tables 14 to 16.

Table 14

10

15

20

25

30

35

40

45

	Chemical shift value (ppm)	
	¹³ C-NMR	¹ H-NMR Chemical shift value, multiplicity, coupling constant
F1-1	90.8	5.44, d, 3.4
F1-2	75.7	4.44, dd, 3.4, 9.8
F1-3	75.9	4.19, dd, 9.8, 2.9
F1-4	80.3	4.84, d, 2.9
F1-5	67.7	4.24, m
F1-6	16.6	1.22, m
F2-1	99.4	5.30, d, 3.0
F2-2	74.9	4.46, m
F2-3	72.5	4.44, m
F2-4	78.4	4.78, br-s
F2-5	68.2	4.29, q, 6.6
F2-6	17.1	1.25, d, 6.6
F3-1	91.2	5.29, br-s
F3-2	74.9	4.11, m
F3-3	75.0	4.28, m
F3-4	74.5	4.78, br-s
F3-5	68.4	4.31, q, 6.6
F3-6	14.5	1.43, d, 6.8
F4-1	98.7	5.40, d, 3.5
F4-2	74.9	4.48, m
F4-3	74.9	4.29, m
F4-4	80.3	4.48, br-s
F4-5	68.4	4.24, m
F4-6	16.6	1.22, m

Table 15

50

55

	Chemical shift value (ppm)	
	¹³ C-NMR	¹ H-NMR Chemical shift value, multiplicity, coupling constant
F5-1	98.0	5.35, d, 3.6
F5-2	73.8	4.51, m
F5-3	71.2	4.39, m

Table 15 (continued)

	Chemical shift value (ppm)	
	¹³ C-NMR	¹ H-NMR Chemical shift value, multiplicity, coupling constant
F5-4	78.4	4.78, m
F5-5	68.2	4.29, m
F5-6	16.9	1.23, m
F6-1	90.5	5.34, br-s
F6-2	74.9	4.11, m
F6-3	75.0	4.29, m
F6-4	74.5	4.78, br-s
F6-5	68.4	4.31, q, 7.0
F6-6	14.2	1.48, d, 7.0
F7-1	95.9	5.33, m
F7-2	73.9	4.48, m
F7-3	71.2	4.37, m
F7-4	78.2	4.78, m
F7-5	67.3	4.46, m
F7-6	16.8	1.23, m

Table 16

	Chemical shift value (ppm)	
	¹³ C-NMR	¹ H-NMR Chemical shift value, multiplicity, coupling constant
F8-1	96.2	5.33, d, 3.3
F8-2	75.7	4.38, m
F8-3	67.3	4.31, m
F8-4	82.2	4.62, d, 3.1
F8-5	67.3	4.38, m
F8-6	16.4	1.20, m
F9-1	99.7	5.25, d, 4.4
F9-2	66.5	3.88, dd, 4.4, 10.2
F9-3	78.7	4.48, m
F9-4	70.9	4.10, m
F9-5	67.5	4.08, q, 6.6
F9-6	16.2	1.17, d, 6.6
F10-1	99.7	5.26, d, 4.4
F10-2	66.5	3.90, dd, 4.4, 10.2
F10-3	78.7	4.49, m
F10-4	70.9	4.11, m

Table 16 (continued)

	Chemical shift value (ppm)	
	¹³ C-NMR	¹ H-NMR Chemical shift value, multiplicity, coupling constant
F10-5	67.5	4.12, q, 6.6
F10-6	16.3	1.17, d, 6.6

Saccharide composition: L-fucose (10 molecules)

Sulfate group: 16 molecules

Sodium: 16 molecules

[0104] The numbers for signal assignment in ¹H-NMR and ¹³C-NMR analyses are as indicated in formula (IX) below:

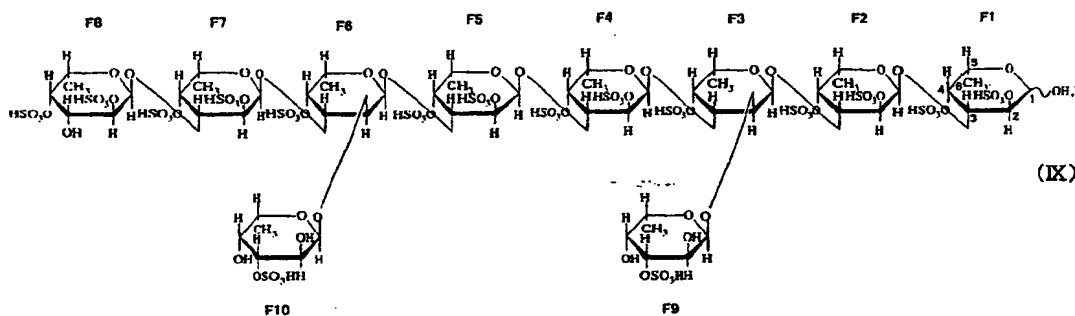

Example 4: The preparation of *Laminaria japonica* sulfated fucan oligosaccharides using sulfated fucan-digesting enzyme, their purification, and their structural analyses

(1) Preparation

[0105] Dried cultured *Laminaria japonica* was disrupted into chips using a cutter mill (Masuko Sangyo) equipped with a screen having a pore diameter of 1 mm. Five hundred grams of *Laminaria japonica* chips were suspended in 4.5 L of 80% ethanol, stirred at room temperature for 24 hours, and filtered. The residue was washed with 80% ethanol for three times by the same method as described above, and the washed *Laminaria japonica* chips were obtained. All the washed chips were suspended in 10 L of 50 mM imidazole-HCl buffer (pH 8.0) containing 50 mM calcium chloride, 200 mM sodium chloride, and 10% ethanol, to the suspension was added 2 U of the sulfated fucan-digesting enzyme, stirred at room temperature for 5 days, filtered through filter paper, thus obtained filtrate was centrifuged, and the supernatant was fractionated using an ultrafiltration device equipped with hollow fibers with exclusion molecular weight of 10,000, and the low molecular weight fraction was recovered and designated as a *Laminaria japonica* sulfated fucan oligosaccharide fraction 1.

(2) Purification

[0106] The conductivity of the solution of the *Laminaria japonica* sulfated fucan oligosaccharide fraction 1 obtained in Example 4-(1) was adjusted by adding 10% ethanol to the same conductivity of the equilibration buffer described below, and it was applied to 500 ml of DEAE-Cellulofine A-800 column equilibrated with 20 mM imidazole-HCl buffer (pH 6.5) containing 200 mM sodium chloride and 10% ethanol, then the column was washed with the same buffer, and eluted with a linear gradient of sodium chloride from 200 mM to 1.2 M. For the elution, 4.5 L of the buffer was used, and fractions of 50 ml were collected. The total sugar content and the total uronic acid content of each of the eluted fractions were measured by the phenol-sulfuric acid method and carbazole-sulfuric acid method, respectively. As a result, the eluted fractions formed 3 peaks. Fractions around the second peak (44-48) were pooled, concentrated to 40 ml by evaporator, applied to Cellulofine GCL-25 column (4.1 x 90 cm) equilibrated with 10% ethanol, and eluted with 10% ethanol. The total sugar of each of the eluted fractions was determined by phenol-sulfuric acid method. The fractions in which sugar was detected were pooled, concentrated to 8.4 ml by evaporator, and purified by the condition

described below.

Column: YMC Pack Polyamine II (20 x 250 mm, YMC)

Flow rate: 8 ml/minute

Column temperature: 30°C

Equilibration solution: 875 mM sodium dihydrogenphosphate containing 10% acetonitrile

Elution: Gradient from 875 mM sodium dihydrogenphosphate containing 10% acetonitrile to 1.4 M sodium dihydrogenphosphate containing 10% acetonitrile

Fractionation: 4 ml/fraction

Detection: by the phenol-sulfuric acid method

[0107] Fractions obtained by the column chromatography shown above (3 times, fraction number around 50-59) were pooled, dialyzed against 10% ethanol using a dialysis tube of which the exclusion molecular weight is 3,500, concentrated to about 40 ml by evaporator, applied to Cellulofine GCL-25 column equilibrated with 10% ethanol, and eluted with 10% ethanol.

[0108] The total sugar of each of the eluted fractions was determined by the phenol-sulfuric acid method. The fractions around the main peak were pooled and purified again by Cellulofine GCL-25 as described above. The fractions around the main peak of these eluted fractions were pooled, concentrated by Speed Vac, and lyophilized. Thus *Laminaria japonica* sulfated fucan oligosaccharide 1 was obtained.

(3) Structural analyses

[0109] By the structural analyses of the oligosaccharide as shown in Example 2, the structure of *Laminaria japonica* sulfated fucan oligosaccharide 1 was determined to be the same structure as the sulfated fucan oligosaccharide 1-(3) shown in Example 2.

Example 5: Preparation, purification, and structural analyses of *Lessonia nigrescens* sulfated fucan oligosaccharide

(1) Preparation

[0110] By the method shown in Referential Example 1, *Lessonia nigrescens* fucoidan was prepared from dried chips of *Lessonia nigrescens*.

[0111] Namely, 10 g of *Lessonia nigrescens* fucoidan was dissolved in 2 L of 50 mM imidazole-HCl buffer (pH 8.0) containing 50 mM calcium chloride, 300 mM sodium chloride, and 10% ethanol. To the solution was added 1 U of sulfated fucan-digesting enzyme, stirred at room temperature for 40 hours, and recovered its low molecular weight fraction using an ultrafiltration device equipped with hollow fibers with exclusion molecular weight of 10,000, and thus obtained fraction was designated as a *Lessonia nigrescens* sulfated fucan oligosaccharide fraction 1.

(2) Purification

[0112] *Lessonia nigrescens* sulfated fucan oligosaccharide fraction 1 obtained in (1) was applied to 1000 ml of DE-AE-Cellulofine A-800 column equilibrated with 10 mM imidazole-HCl buffer (pH 6.0) containing 200 mM sodium chloride and 10% ethanol, then the column was washed with the same buffer, and eluted with a linear gradient of sodium chloride from 200 mM to 700 mM. For the elution, 5 L of the buffer was used, and fractions of 56 ml were collected. The total sugar content and the total uronic acid content of each of the eluted fractions were measured by the phenol-sulfuric acid method and carbazole-sulfuric acid method, respectively. As a result, the eluted fractions formed 7 peaks. Fractions around the each peak were pooled separately, concentrated to 40 ml by evaporator (they are designated as *Lessonia nigrescens* sulfated fucan oligosaccharides 1-(1) to 1-(7)), applied to Cellulofine GCL-25 column (4.1 x 90 cm) equilibrated with 10% ethanol, and eluted with 10% ethanol. The total sugar of each of the eluted fractions was determined by phenol-sulfuric acid method. The fractions in which sugar was detected were pooled, concentrated by evaporator, and purified by the condition described below.

Column: YMC Pack Polyamine II (20 x 250 mm, YMC)

Flow rate: 8 ml/minute

Column temperature: 30°C

Equilibration solution: For *Lessonia nigrescens* sulfated fucan oligosaccharides 1-(1), (2), and (3), 90 mM sodium dihydrogenphosphate containing 10% acetonitrile. For *Lessonia nigrescens* sulfated fucan oligosaccharide 1-(4) and (5), 630 mM sodium dihydrogenphosphate containing 10% acetonitrile. For *Lessonia nigrescens* sulfated fucan oligosaccharide 1-(6), 720 mM sodium dihydrogenphosphate containing 10% acetonitrile. For *Lessonia nigrescens* sulfated fucan oligosaccharide 1-(7), 900 mM sodium dihydrogenphosphate containing 10% acetonitrile.

Elution: For *Lessonia nigrescens* sulfated fucan oligosaccharides 1-(1), (2), and (3), with the gradient from 90

mM sodium dihydrogenphosphate containing 10% acetonitrile to 900 mM sodium dihydrogenphosphate containing 10% acetonitrile. For *Lessonia nigrescens* sulfated fucan oligosaccharides 1-(4) and (5), with the gradient from 630 mM sodium dihydrogenphosphate containing 10% acetonitrile to 1260 mM sodium dihydrogenphosphate containing 10% acetonitrile. For *Lessonia nigrescens* sulfated fucan oligosaccharide 1-(6), with the gradient from 720 mM sodium dihydrogenphosphate containing 10% acetonitrile to 1440 mM sodium dihydrogenphosphate containing 10% acetonitrile. For *Lessonia nigrescens* sulfated fucan oligosaccharide 1-(7), with the gradient from 900 mM sodium dihydrogenphosphate containing 10% acetonitrile to 1620 mM sodium dihydrogenphosphate containing 10% acetonitrile.

Fractionation: 4 ml/fraction

Detection: by the phenol-sulfuric acid method

[0113] *Lessonia nigrescens* sulfated fucan oligosaccharides from 1-(1) to 1-(7) were fractionated by the column chromatography shown above, and the fractions in which sugar was detected were pooled, concentrated to about 40 ml by evaporator, applied to Cellulofine GCL-25 column equilibrated with 10% ethanol, and eluted with 10% ethanol.

[0114] The total sugar of each of the eluted fractions was determined by the phenol-sulfuric acid method. The fractions around the main peak were pooled and purified again by Cellulofine GCL-25 as described above. As for *Lessonia nigrescens* sulfated fucan oligosaccharide 1-(7), two main peaks were observed, therefore, the two peaks were designated as *Lessonia nigrescens* sulfated fucan oligosaccharides 1-(7)-1 and 1-(7)-2.

[0115] The fractions around the main peak of each of these eluted fractions were pooled, concentrated by Speed Vac, and lyophilized. Thus *Lessonia nigrescens* sulfated fucan oligosaccharides from 1-(1) to 1-(7)-2 were obtained.

(3) Structural analyses

[0116] The structural analyses of these oligosaccharides were carried out as described in Example 2.

[0117] Physical properties of the *Lessonia nigrescens* sulfated fucan oligosaccharides 1-(1) to 1-(7)-2 of the present invention are shown below.

(a) Physical properties of *Lessonia nigrescens* sulfated fucan oligosaccharide 1-(1)

[0118] The results for the mass spectrometric analysis and assignment in NMR analyses are shown below, and the $^1\text{H-NMR}$ spectrum, $^{13}\text{C-NMR}$ spectrum, and the mass spectrum of this oligosaccharide are shown in Figures 19, 20, and 21, respectively. In Figures 19 and 20, the vertical axes represent the signal intensity and the horizontal axes represent the chemical shift value (ppm). In Figure 21, the vertical axis represents the relative intensity of the signals and the horizontal axis represents the m/z value.

Molecular weight; 718

MS m/z 216.5 $[\text{M}-3\text{Na}^+]^2-$, 336.0 $[\text{M}-2\text{Na}^+]^2-$, 695.0 $[\text{M}-\text{Na}^+]$

[0119] The results of $^1\text{H-NMR}$ and $^{13}\text{C-NMR}$ analyses are shown in Table 17.

Table 17

	Chemical shift value (ppm)	
	$^{13}\text{C-NMR}$	$^1\text{H-NMR}$ Chemical shift value, multiplicity, coupling constant
F1-1	90.8	5.41, d, 3.6
F1-2	75.1	4.38, dd, 3.6, 10.8
F1-3	75.1	4.11, dd, 10.8, 3.0
F1-4	81.0	4.84, d, 3.0
F1-5	66.7	4.22, q, 6.0
F1-6	16.2	1.16, d, 6.0
F2-1	99.2	5.21, d, 3.0
F2-2	76.4	4.29, m
F2-3	67.8	4.29, m
F2-4	81.5	4.55, d, 3.0
F2-5	67.8	4.31, q, 6.6

Table 17 (continued)

	Chemical shift value (ppm)	
	¹³ C-NMR	¹ H-NMR Chemical shift value, multiplicity, coupling constant
F2-6	16.3	1.16, d, 6.6

Component sugar: only L-fucose (2 molecules)

Sulfate residues: 4 molecules

Sodium: 4 molecules

[0120] The numbers for signal assignment in ¹H-NMR and ¹³C-NMR analyses are as indicated in formula (X) below:

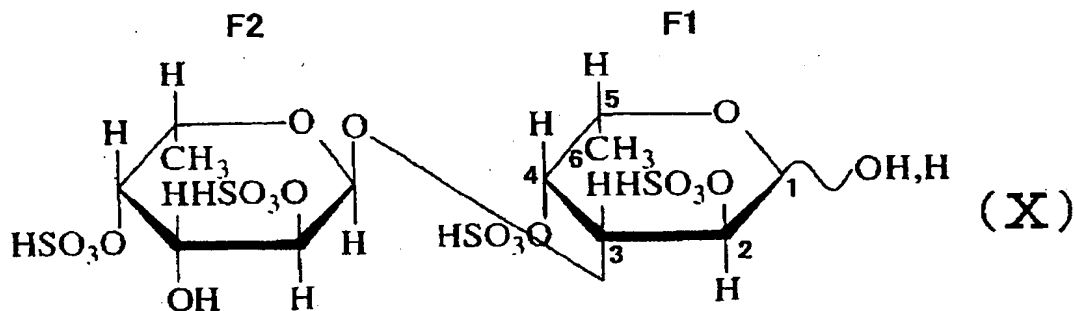

(b) Physical properties of *Lessonia nigrescens* sulfated fucan oligosaccharide 1-(2)

[0121] The results for the mass spectrometric analysis and assignment in NMR analyses are shown below, and the ¹H-NMR spectrum, ¹³C-NMR spectrum, and the mass spectrum of the *Lessonia nigrescens* sulfated fucan oligosaccharide 1-(2) are shown in Figures 22, 23, and 24, respectively. In Figures 22 and 23, the vertical axes represent the signal intensity and the horizontal axes represent the chemical shift value (ppm). In Figure 24, the vertical axis represents the relative intensity of the signals and the horizontal axis represents the m/z value.

Molecular weight: 966

MS m/z 459.9[M-2Na⁺]²⁻, 942.9[M-Na⁺]⁻

[0122] The results of ¹H-NMR and ¹³C-NMR analyses are shown in Table 18.

Table 18

	Chemical shift value (ppm)	
	¹³ C-NMR	¹ H-NMR Chemical shift value, multiplicity, coupling constant
F1-1	90.6	5.42, d, 3.6
F1-2	75.7	4.22, dd, 3.6, 10.4
F1-3	73.8	4.24, dd, 10.4, 2.4
F1-4	80.5	4.79, d, 2.4
F1-5	66.9	4.24, q, 6.4
F1-6	16.3	1.18, d, 6.4
F2-1	98.3	5.32, d, 2.0
F2-2	74.9	4.41, m
F2-3	72.5	4.41, m
F2-4	79.8	4.72, br-s

Table 18 (continued)

	Chemical shift value (ppm)	
	¹³ C-NMR	¹ H-NMR Chemical shift value, multiplicity, coupling constant
F2-5	67.8	4.30, q, 6.5
F2-6	16.3	1.17, d, 6.5
F3-1	97.7	5.03, d, 3.9
F3-2	69.0	3.66, dd, 3.9, 10.5
F3-3	69.3	3.93, dd, 10.5, 2.8
F3-4	81.4	4.51, d, 2.8
F3-5	66.9	4.46, q, 6.4
F3-6	16.3	1.19, d, 6.4

Component sugar: only L-fucose (3 molecules)

Sulfate residues: 5 molecules

Sodium: 5 molecules

[0123] The numbers for signal assignment in ¹H-NMR and ¹³C-NMR analyses are as indicated in formula (XI) below:

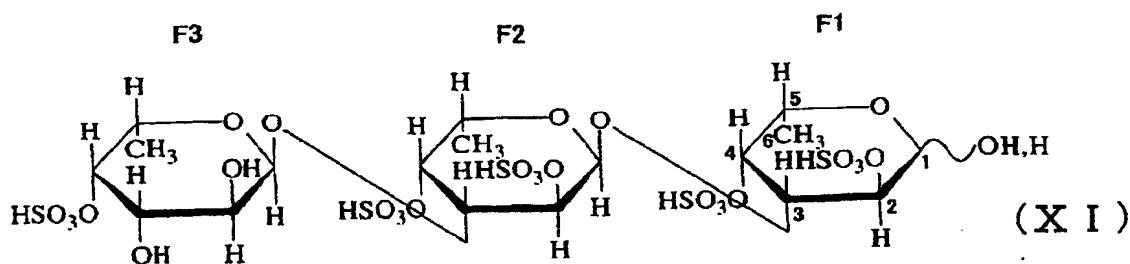

(c) Physical properties of *Lessonia nigrescens* sulfated fucan oligosaccharide 1-(3)

[0124] The results for the mass spectrometric analysis and assignment in NMR analyses are shown below, and the ¹H-NMR spectrum, ¹³C-NMR spectrum, and the mass spectrum are shown in Figures 25, 26, and 27, respectively. In Figures 25 and 26, the vertical axes represent the signal intensity and the horizontal axes represent the chemical shift value (ppm). In Figure 27, the vertical axis represents the relative intensity of the signals and the horizontal axis represents the m/z value.

Molecular weight: 1068

MS m/z 332.9 [M-3Na⁺]³⁻, 511.0 [M-2Na⁺]²⁻, 1045.0 [M-Na⁺]

[0125] The results of ¹H-NMR and ¹³C-NMR analyses are shown in Table 19.

Table 19

	Chemical shift value (ppm)	
	¹³ C-NMR	¹ H-NMR Chemical shift value, multiplicity, coupling constant
F1-1	90.3	5.42, d, 3.4
F1-2	75.5	4.39, dd, 3.4, 10.2
F1-3	74.6	4.22, dd, 10.2, 2.9

Table 19 (continued)

	Chemical shift value (ppm)	
	¹³ C-NMR	¹ H-NMR Chemical shift value, multiplicity, coupling constant
F1-4	78.0	4.80, d, 2.9
F1-5	67.3	4.24, q, 6.6
F1-6	16.3	1.20, d, 6.6
F2-1	98.8	5.30, d, 3.3
F2-2	75.0	4.41, m
F2-3	75.0	4.30, m
F2-4	80.7	4.81, d, 2.6
F2-5	68.4	4.25, q, 6.7
F2-6	16.2	1.18, d, 6.7
F3-1	98.5	5.24, d, 3.2
F3-2	75.7	4.31, dd, 3.2, 10.4
F3-3	66.5	4.26, dd, 10.4, 3.0
F3-4	81.7	4.57, d, 3.0
F3-5	67.4	4.36, q, 6.6
F3-6	16.0	1.20, d, 6.6

Component sugar: only L-fucose (3 molecules)

Sulfate residues: 6 molecules

Sodium: 6 molecules

[0126] The numbers for signal assignment in ¹H-NMR and ¹³C-NMR analyses are as indicated in formula (XII) below:

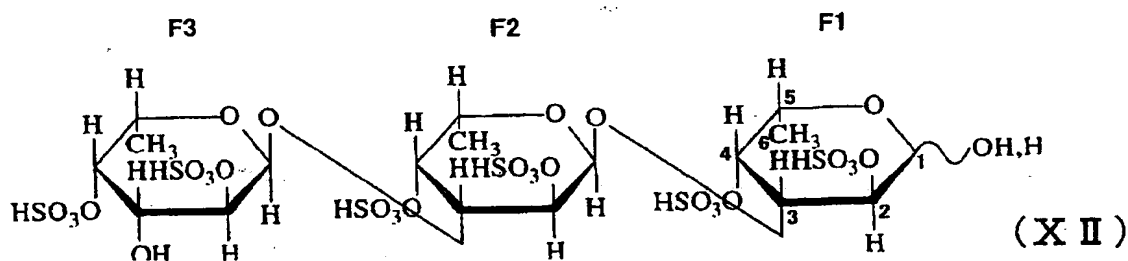

(d) Physical properties of *Lessonia nigrescens* sulfated fucan oligosaccharide 1-(4)

[0127] By the structural analyses of the oligosaccharide as shown in Example 2, the structure of *Lessonia nigrescens* sulfated fucan oligosaccharide 1-(4) was determined to be the same structure as the sulfated fucan oligosaccharide 1-(2) shown in Example 2.

(e) Physical properties of *Lessonia nigrescens* sulfated fucan oligosaccharide 1-(5)

[0128] By the structural analyses of the oligosaccharide as shown in Example 2, the structure of *Lessonia nigrescens* sulfated fucan oligosaccharide 1-(5) was determined to be the same structure as the sulfated fucan oligosaccharide 1-(3) shown in Example 2.

(f) Physical properties of *Lessonia nigrescens* sulfated fucan oligosaccharide 1-(6)

[0129] The results of the mass spectrometric analysis for *Lessonia nigrescens* sulfated fucan oligosaccharides 1-(6) of the present invention are shown below.

Molecular weight: 3461

MS m/z 361.5 [M-9Na⁺]⁹⁻, 409.62 [M-8Na⁺]⁸⁻, 471.42 [M-7Na⁺]⁷⁻, 553.81 [M-6Na⁺]⁶⁻, 669.31 [M-5Na⁺]⁵⁻, 842.32 [M-4Na⁺]⁴⁻, 1130.83 [M-3Na⁺]³⁻

Component sugar: only L-fucose (11 molecules)

Sulfate residues: 18 molecules

Sodium: 18 molecules

(g) Physical properties of *Lessonia nigrescens* sulfated fucan oligosaccharide 1-(7)-1

[0130] The results of the mass spectrometric analysis for *Lessonia nigrescens* sulfated fucan oligosaccharide 1-(7)-1 of the present invention are shown below.

Molecular weight: 4659

MS m/z 442.82 [M-10Na⁺]¹⁰⁻, 494.72 [M-9Na⁺]⁹⁻, 559.32 [M-8Na⁺]⁸⁻, 642.62 [M-7Na⁺]⁷⁻, 753.52 [M-6Na⁺]⁶⁻, 908.82 [M-5Na⁺]⁵⁻, 1141.43 [M-4Na⁺]⁴⁻

Component sugar: only L-fucose (15 molecules)

Sulfate residues: 24 molecules

Sodium: 24 molecules

(h) Physical properties of *Lessonia nigrescens* sulfated fucan oligosaccharide 1-(7)-2

[0131] The results of the mass spectrometric analysis for *Lessonia nigrescens* sulfated fucan oligosaccharide 1-(7)-2 of the present invention are shown below.

Molecular weight: 3564

MS m/z 373.12 [M-9Na⁺]⁹⁻, 422.52 [M-8Na⁺]⁸⁻, 486.32 [M-7Na⁺]⁷⁻, 571.01 [M-6Na⁺]⁶⁻, 689.61 [M-5Na⁺]⁵⁻, 868.02 [M-4Na⁺]⁴⁻, 1164.93 [M-3Na⁺]³⁻

Component sugar: only L-fucose (11 molecules)

Sulfate residues: 19 molecules

Sodium: 19 molecules

Example 6: Preparation of sulfated fucan oligosaccharide using sulfated fucan-digesting enzyme, and purification and structural analysis thereof

(1) Preparation

[0132] 10 g of the fucoidan from cultured *Kjellmaniella crassifolia* as described in Referential Example 1 was dissolved in 4.8 L of 17 mM imidazole-hydrochloride buffer (pH 7.5) containing 125 mM calcium chloride, 250 mM sodium chloride and 10% ethanol. 10 U of the sulfated fucan-digesting enzyme was added thereto. The resulting mixture was stirred at room temperature for 72 hours to obtain a *Kjellmaniella crassifolia* fucoidan oligosaccharide solution. A small molecule fraction recovered from the solution using an ultrafiltration device equipped with hollow fibers with exclusion molecular weight of 10,000 was designated as a sulfated fucan oligosaccharide fraction 3.

(2) Analysis

[0133] The sulfated fucan oligosaccharide fraction 3 obtained in (1) above was loaded onto a 1-L DEAE-Cellulofine A-800 column equilibrated with 10 mM imidazole-hydrochloride buffer (pH 6.5) containing 100 mM sodium chloride. After adequately washing with the same buffer, elution was then carried out with a gradient of 100 mM to 1 M sodium chloride. The total sugar content and the total uronic acid content of each of the eluted fractions were measured according to the phenol-sulfuric acid method and the carbazole-sulfuric acid method, respectively. As a result, the eluted fractions formed two peaks. The fractions in the respective peaks were subjected to mass spectrometric analyses. Determination of the saccharide compositions for the respective peaks showed that they contained only fucose but did not contain uronic acid. Compositions of the oligosaccharides having the respective masses estimated based on the saccharide compositions are shown in Table 20.

Table 20

Peak no.	Molecular weight	Composition of oligosaccharide		
		Fucose	Sulfate group	Sodium
3-(1)	1564	5	8	8
	1914	6	10	10
	2016	6	11	11
	2162	7	11	11
	2264	7	12	12
	2410	8	12	12
3-(2)	3110	10	16	16
	3360	11	17	17
	3462	11	18	18
	3710	12	19	19
	4308	14	22	22

[0134] It was shown that the sulfated fucan oligosaccharide fraction 3 contained various sulfated fucan oligosaccharides as shown in the table above.

Example 7: Preparation of sulfated fucan oligosaccharide using sulfated fucan-digesting enzyme, and purification, structural analysis and physiological activity thereof

[0135] (1) In addition to the four distinct peaks observed in DEAE-Cellulofine column chromatography as described in Example 2-(2), a broad peak eluted with a higher salt concentration was observed. It was collected, designated as an oligosaccharide 4 and subjected to NMR analysis as described in Example 2. As a result, a spectrum almost identical to that for the sulfated fucan oligosaccharide 1-(2) was observed. These results strongly suggested that the oligosaccharide 4 had a structure in which several molecules of the oligosaccharide 1-(2) were connected each other. Then, the oligosaccharide 4 was digested using the sulfated fucan-digesting enzyme as described in Example 1, and the digestion product was analyzed using HPLC. The majority of the reaction products was eluted at the same position as that for the sulfated fucan oligosaccharide 1-(2).

[0136] The molecular weight of the oligosaccharide 4 as determined by gel filtration using pullulan as a standard substance was shown to be about triple of the oligosaccharide 1-(2).

[0137] Precise analysis of the ¹H-NMR spectrum for the oligosaccharide 4 revealed that the repeat of seven saccharide residues was bound at the 3-position of fucose F6 in formula (IV) via an α-(1→3) bond.

[0138] A monomer to a pentamer of the sulfated saccharide represented by general formula (I) (i.e., sulfated saccharides of general formula (I) wherein n = 1 to 5) were obtained from digestion products of a sulfated polysaccharide according to the method as described above.

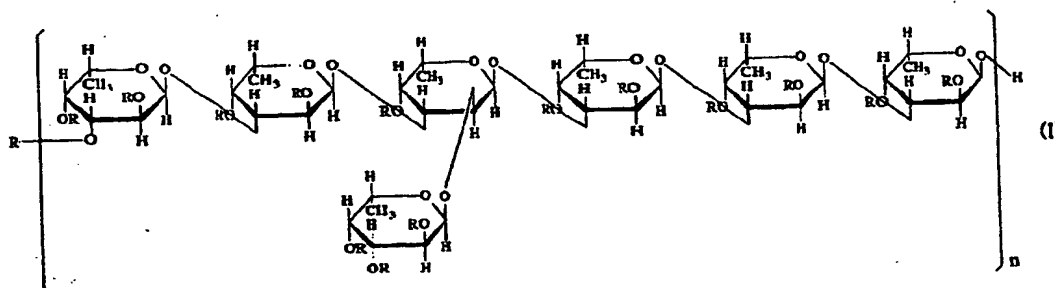

wherein R is H or SO₃H and at least one of Rs is SO₃H.

[0139] As described above, it was confirmed that a sulfated fucan-containing polysaccharide obtained from a brown alga such as *Kjellmaniella crassifolia* was converted into smaller molecules by treating it using a sulfated fucan-digesting enzyme, and that a sulfated polysaccharide containing a sulfated saccharide of the general formula above as an essential component of the constituting saccharide was then obtained. The average molecular weight of the sulfated polysaccharide extracted at pH 6-8 at 95°C for about 2 hour as determined by gel filtration was about 200,000.

[0140] (2) The physiological activities of the sulfated saccharide obtained in (1) above were examined. As a result, an activity of inducing HGF production as determined according to the method described in Example 1-(2) in WO 00/62785 was observed for the sulfated polysaccharide of formula (I). In addition, the sulfated saccharides of formula (I) were shown to be very useful in retaining moisture as determined according to the method described in Examples 8 and 9 in WO 99/41288.

[0141] The present invention provides a method for producing a sulfated fucan oligosaccharide having a varying molecular weight, which is useful as a reagent for glycotechnology, using a sulfated fucan-digesting enzyme. The present invention also provides various sulfated fucan oligosaccharides of which the structures have been determined.

15

20

25

30

35

40

45

50

55

SEQUENCE LISTING

5

<110> TAKARA BIO INC.

10

<120> Sulfated fucan oligosaccharide

15

<130> 38-51

20

<150> JP 2001-325960

<151> 2001-10-24

25

<160> 1

30

<210> 1

<211> 1506

<212> DNA

35

<213> Fucanobacter lyticus

40

<400> 1

agagtttgat cctggctcag attgaacgct ggoggcaggc ttaacacatg caagtcgagc 60

ggaaacgaga atagcttgct attcggcgtc gagcggcgga cgggtgagta atgcttgga 120

45

atatgcctaa tgggtgggga caacagtgg aaacgactgc taataccgca taatgtctac 180

ggaccaaagg aggggattct toggaacctt tcgccatttg attagcccaa gtgagattag 240

ctagtaggta aggtaatggc ttacctaggc gacgatctct agctggtttg agaggatgat 300

50

cagccacact gggactgaga caogggccag actcctacgg gaggcagcag tggggaatat 360

tgcacaatgg gcgaaagcct gatgcagcca tgcgcgtgt gtgaagaagg ccttcgggtt 420

55

gtaaagcact ttcagcgagg aggaaagggt gtagattaat actctgcac tgtgacgta 480

5 ctcgcagaag aagcaccggc taacttcgtg ccagcagccg cggtaatacg aggggtgcaa 540
 6 cgtttaatcg gaattactgg gogtaaagcg tgcgtagggtg gtttgtaag caagatgtga 600
 7 aagccccggg ctcaacctgg gaactgcatt ttgaactggc aactagagt tttgtagagg 660
 10 gtagtggaat ttccagtgta gcggtgaaat gcgtagagat tggaggaac atcagtggcg 720
 11 aaggcggcta cctggacaga gactgacact gaggcacgaa agcgtgggga gcaaacagga 780
 14 ttagataccc tggtagtcca cgccgtaaac gatgtcaact agccgtctgt agacttgatc 840
 15 tgtgggtggc gtagctaacg cgctaagttg accgcctggg gagtacggcc gcaagggtaa 900
 18 aactcaaatg aattgacggg ggccgcaca agcgggtggag catgtggttt aattcgatgc 960
 20 aacgcgaaga acctaccat ccctgacat cctactaagt tactagagat agtttcgtgc 1020
 23 cttcgggaaa gtagtgacag gtgctgcatg gctgtcgtca gctcgtgttg tgaatgttg 1080
 25 ggttaagtcc cgcaacgagc gcaaccccta tccttatttg ctagcgcgta atggcgagaa 1140
 28 ctctaaggag actgcoggtg ataaaccgga ggaaggtggg gacgacgtca agtcatcatg 1200
 30 gcccttacgg gatgggctac acacgtgcta caatggcaag tacagagggc agcaataccg 1260
 31 cgaggtggag cgaatccac aaagcttgtc gtagtccgga ttggagtctg caactcgact 1320
 34 ccatgaagtc ggaatcgcta gtaatcgtag atcagaatgc tacggtgaat acgttcccgg 1380
 35 gccttgta caacogcccg cacacatgg gagtgggttg caaaagaagt ggctagtta 1440
 38 acccttcggg gaggacggtc accactttgt gattcatgac tggggtgaag tcgtaacaag 1500
 40 gtagcc 1506

45 **Claims**

1. A sulfated fucan having the following chemical and physical properties:

- 50 (1) containing fucose as a constituting saccharide;
 51 (2) containing a sulfated saccharide of general formula (I) as an essential component of the constituting sac-
 52 charide:

55

5

10

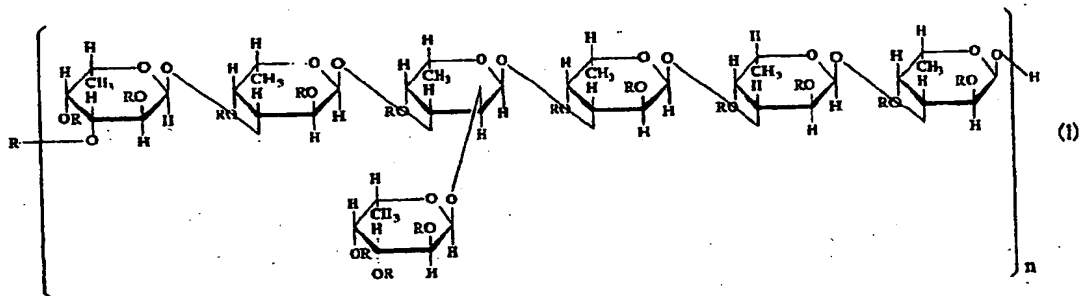

15

wherein R is H or SO₃H, at least one of Rs is SO₃H and n is an integer of 1 or more; and (3) being converted into smaller molecules by a sulfated fucan-digesting enzyme derived from *Alteromonas* sp. SN-1009 to generate at least one compound selected from the group consisting of the compounds of general formulas (II), (III), (XIII), (XIV), (XV) and (XVI):

20

25

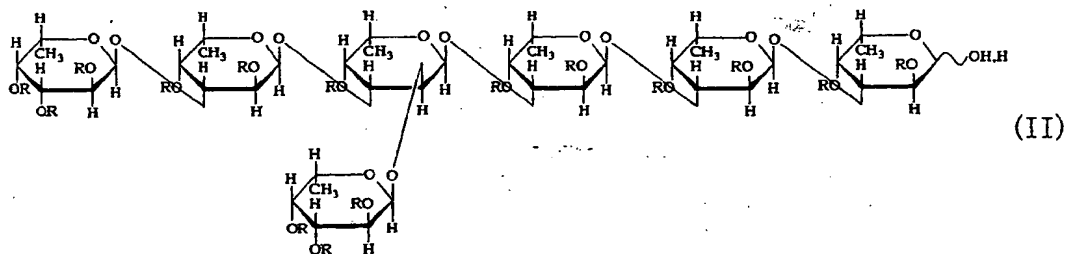

30

35

40

45

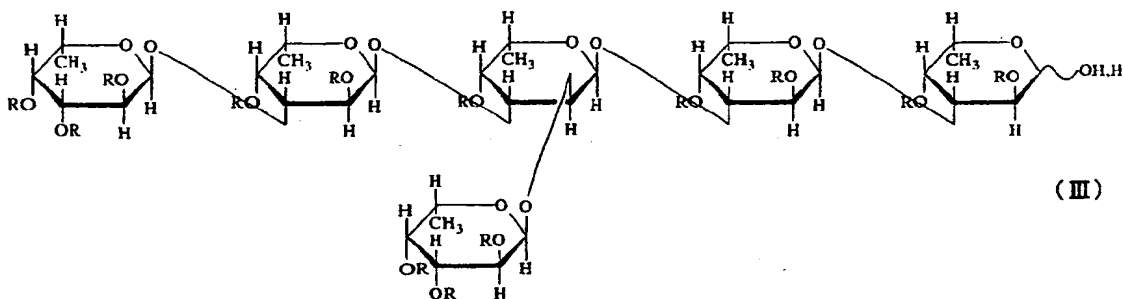

50

55

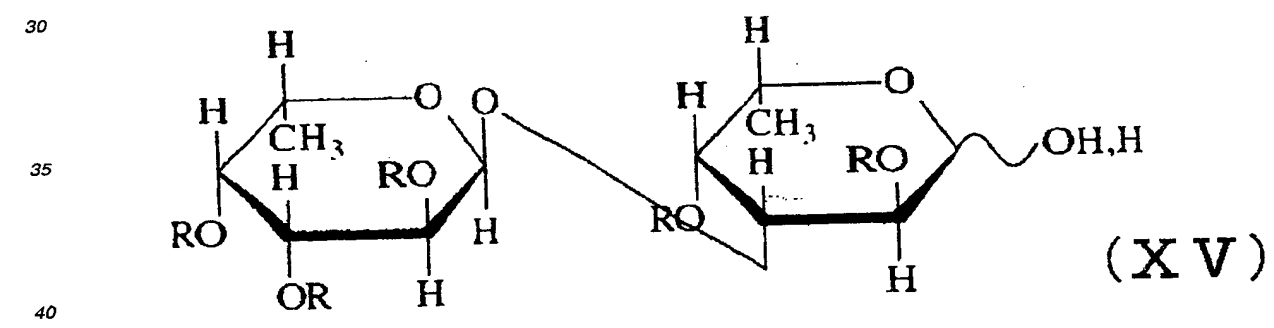
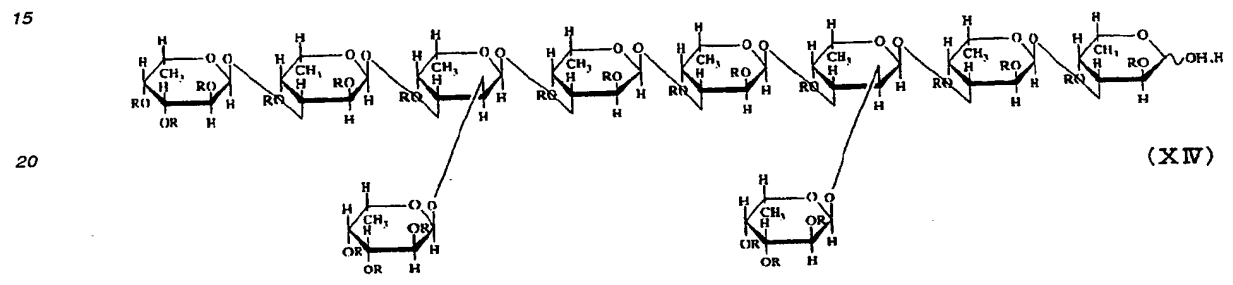
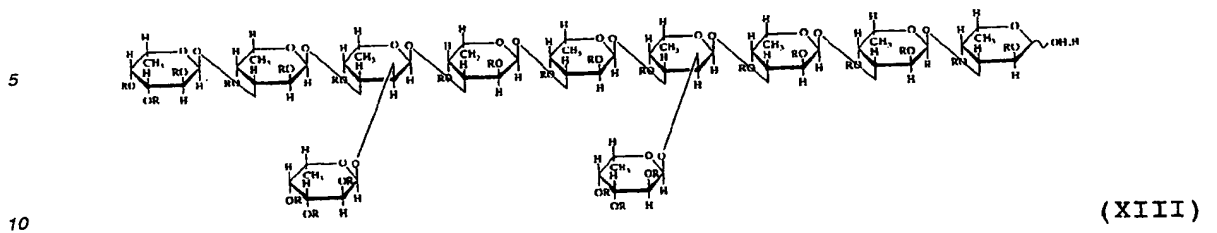

and

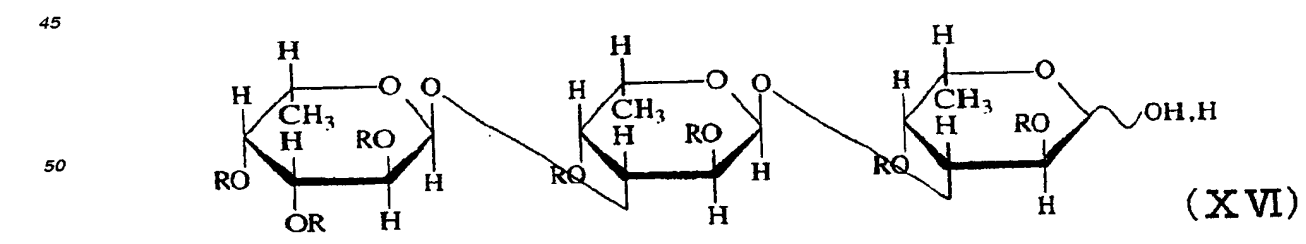

55

wherein R is H or SO₃H and at least one of Rs is SO₃H in all formulas above,
or a salt thereof.

2. A sulfated fucan oligosaccharide of general formula (I):

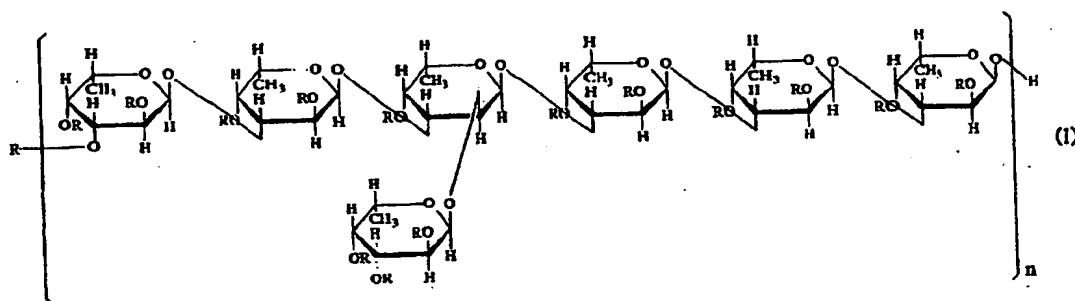

15 wherein R is H or SO₃H, at least one of Rs is SO₃H and n is 1 to 5.

3. A method for preparing a sulfated fucan oligosaccharide, the method comprising:

20 allowing a sulfated fucan-digesting enzyme derived from *Alteromonas* sp. SN-1009 to act on a sulfated fucan defined by claim 1 or 2; and collecting a digestion product.

4. The method according to claim 3, wherein the sulfated fucan is derived from *Kjellmaniella crassifolia*, *Laminaria japonica* or *Lessonia nigrescens*.

5. A sulfated fucan oligosaccharide obtainable by the preparation method defined by claim 3.

6. A sulfated fucan oligosaccharide having a chemical structure selected from the group consisting of general formulas (II), (III), (XIII), (XIV), (XV) and (XVI):

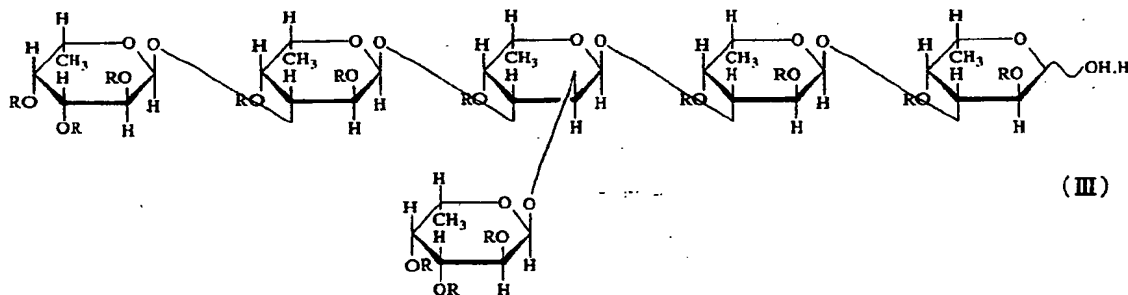
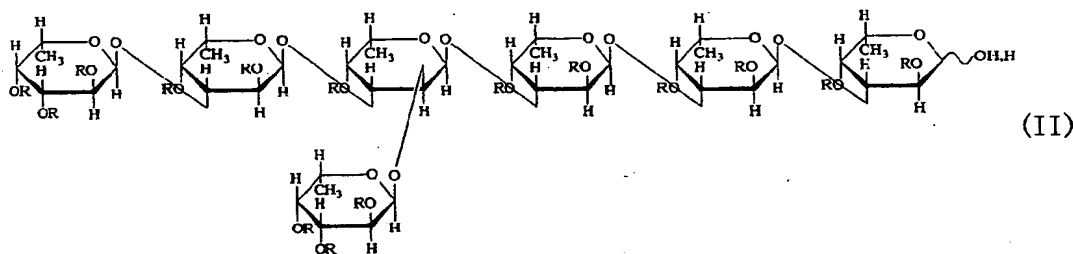

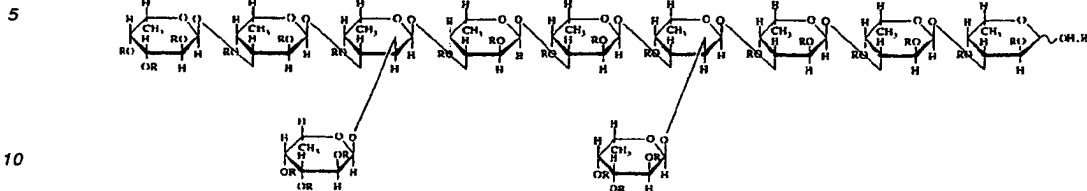

(XIII)

15

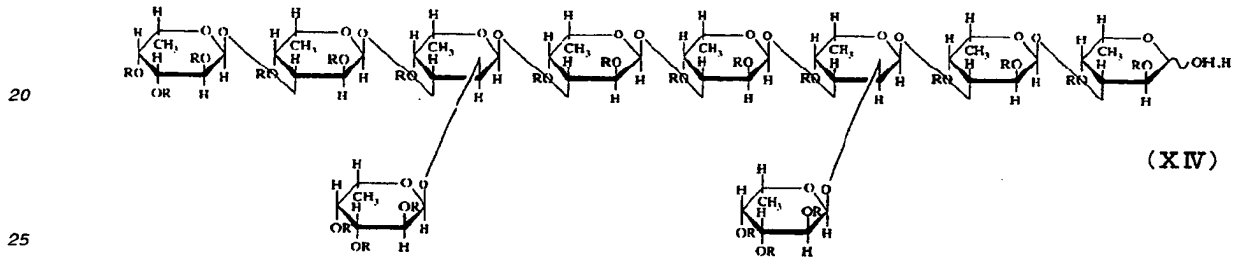

(XIV)

25

30

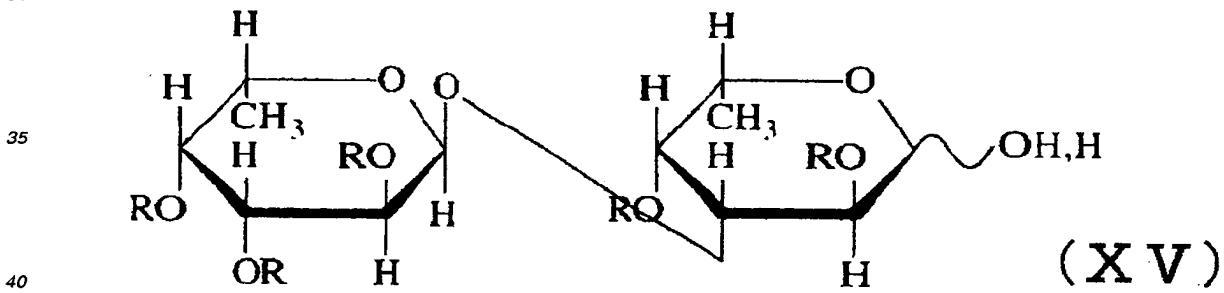

(XV)

and

45

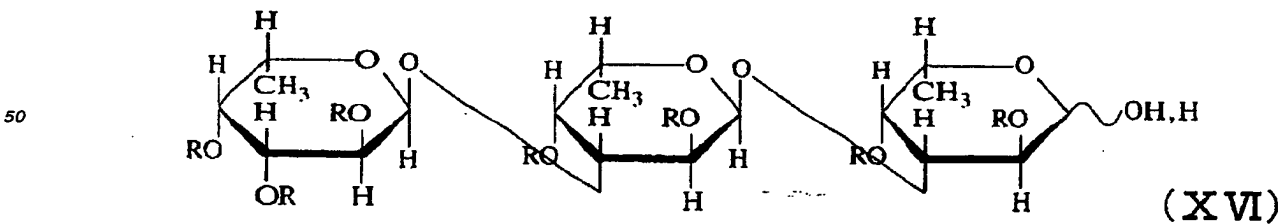

(XVI)

wherein R is H or SO₃H and at least one of Rs is SO₃H in all formulas above,
or a salt thereof.

Fig. 1

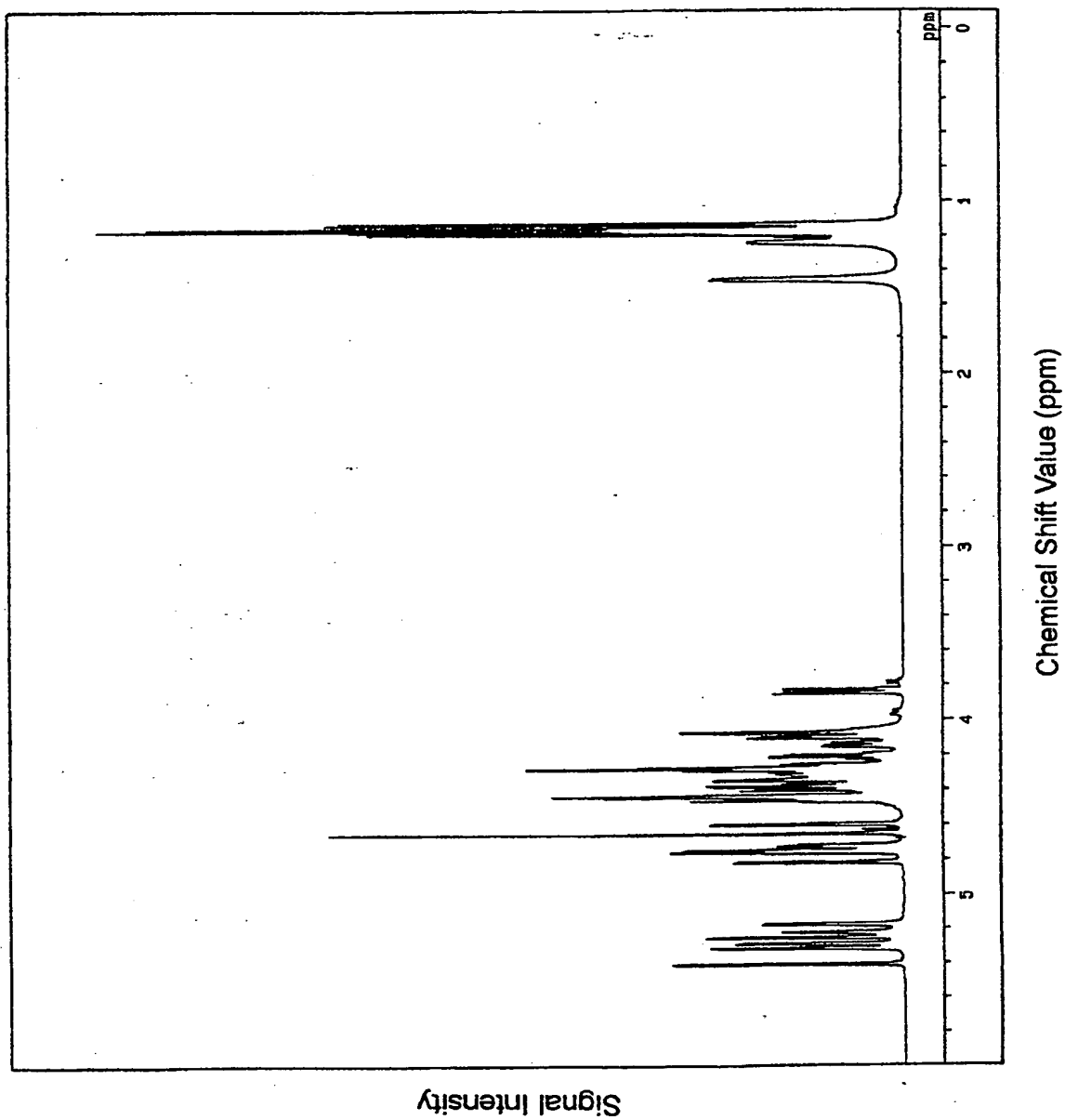

Fig. 2

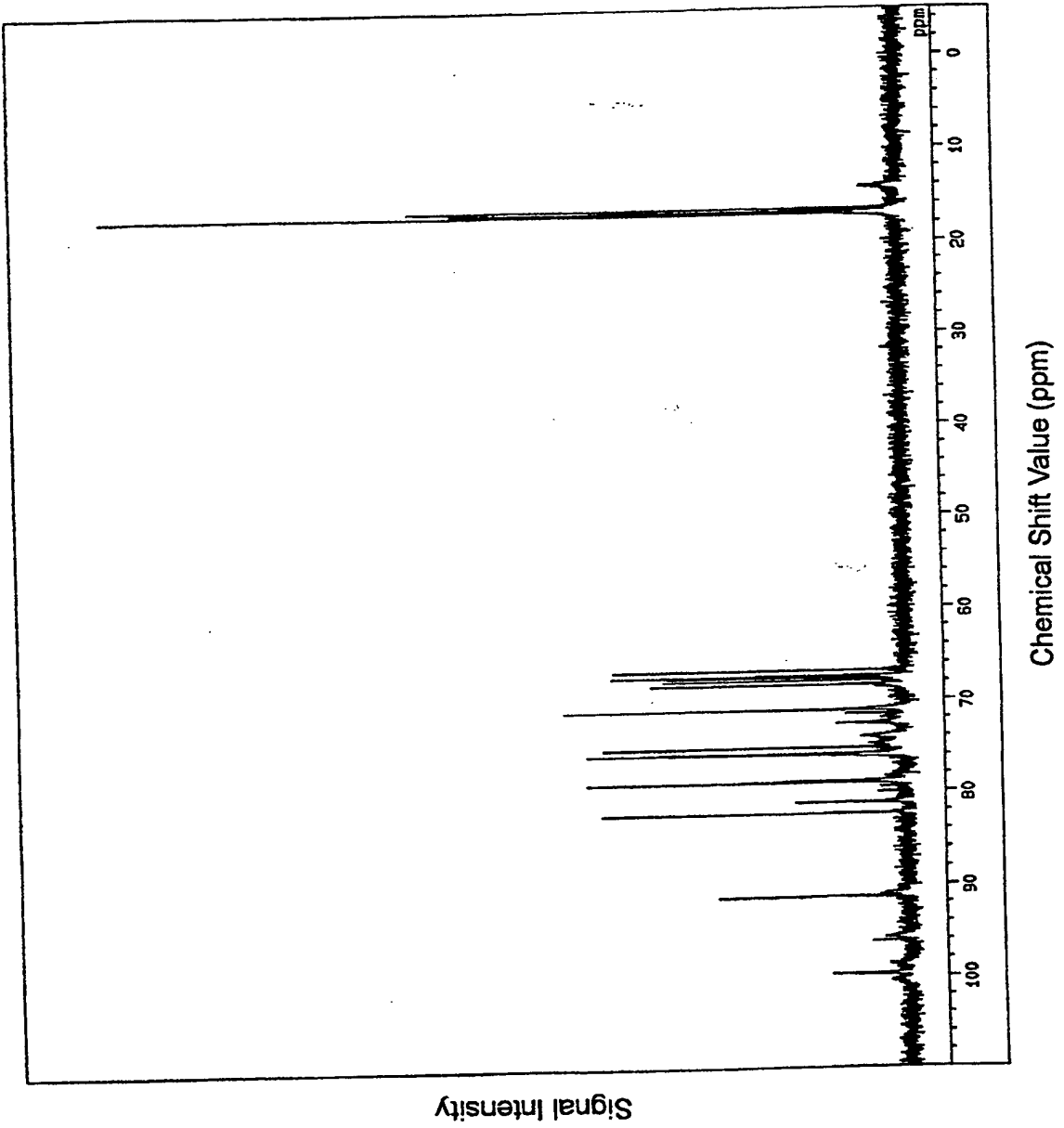

Fig. 3

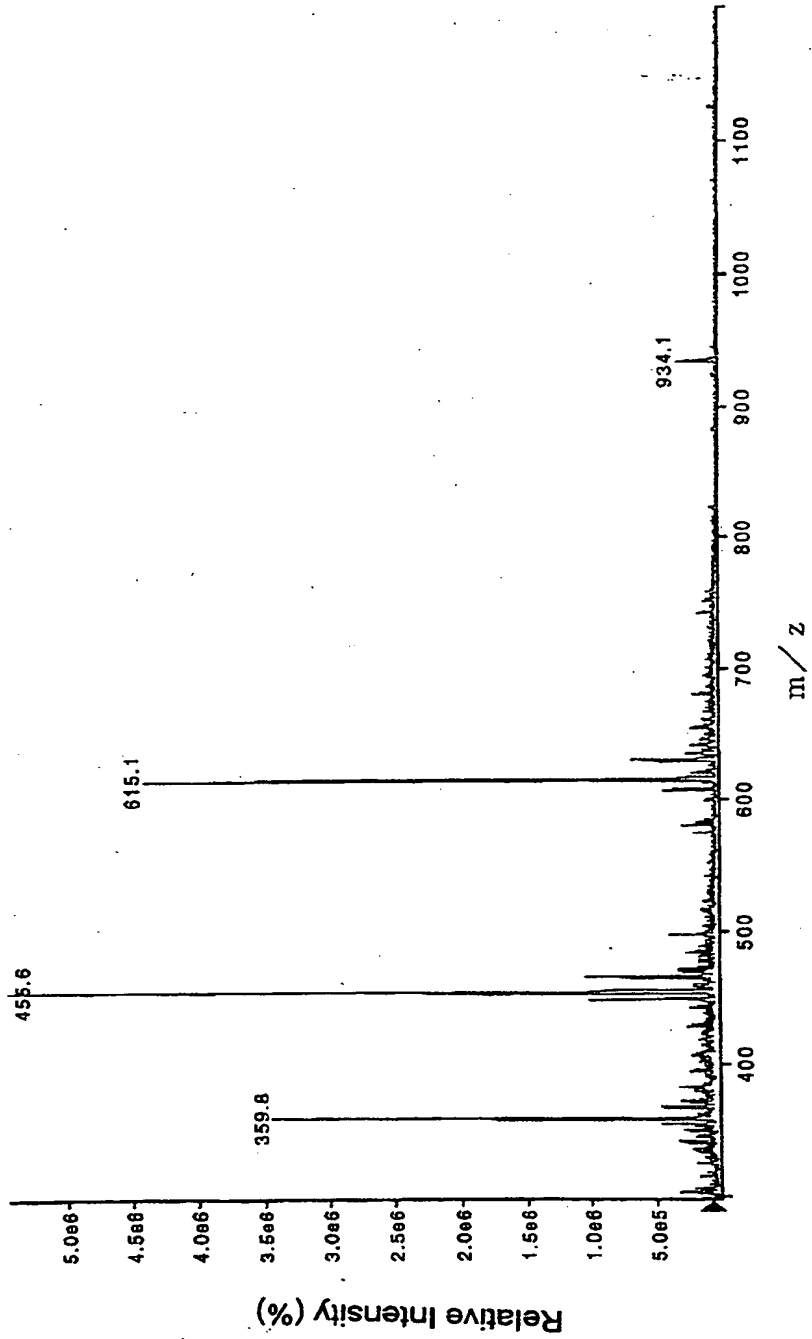

Fig. 4

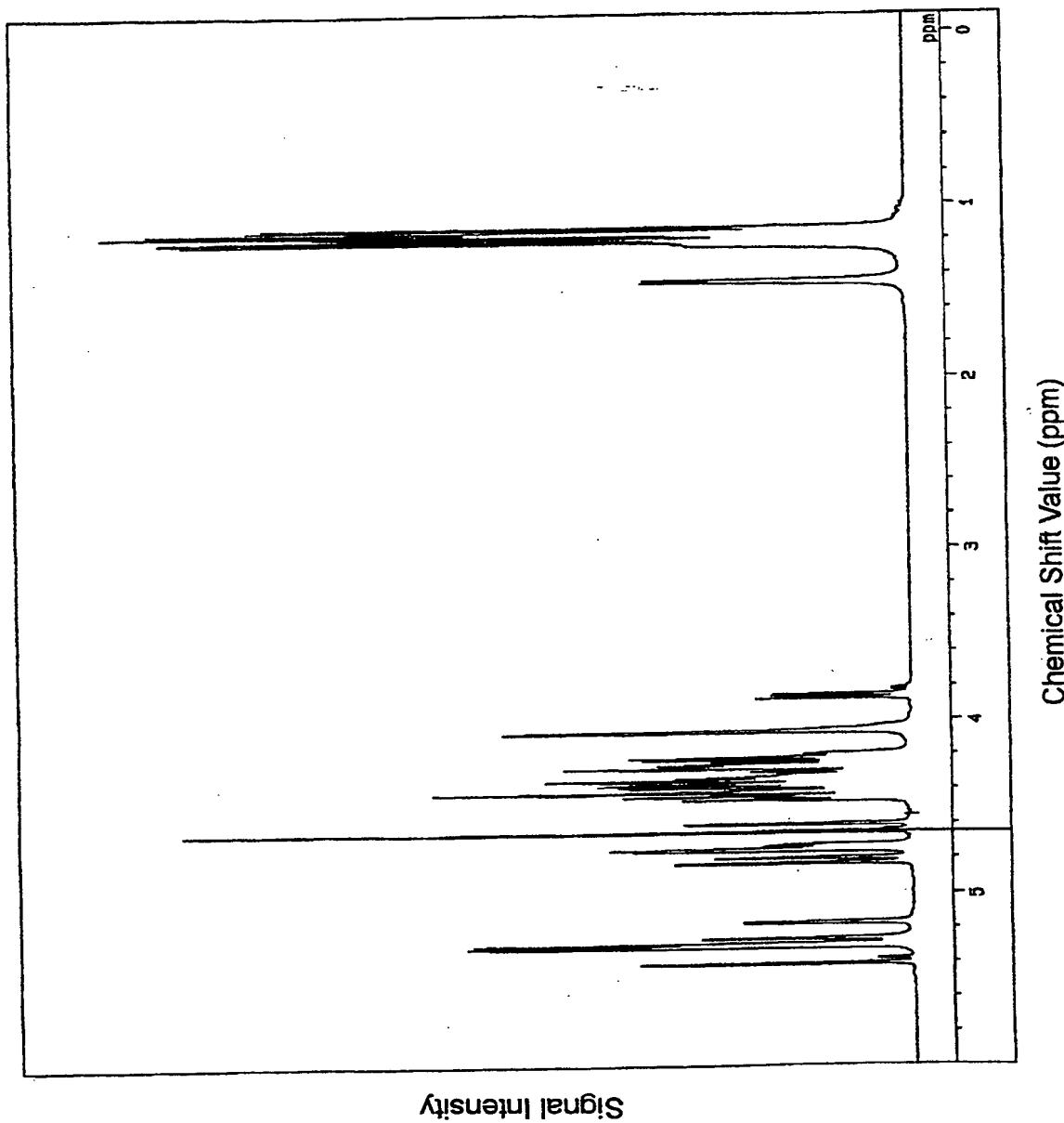

Fig. 5

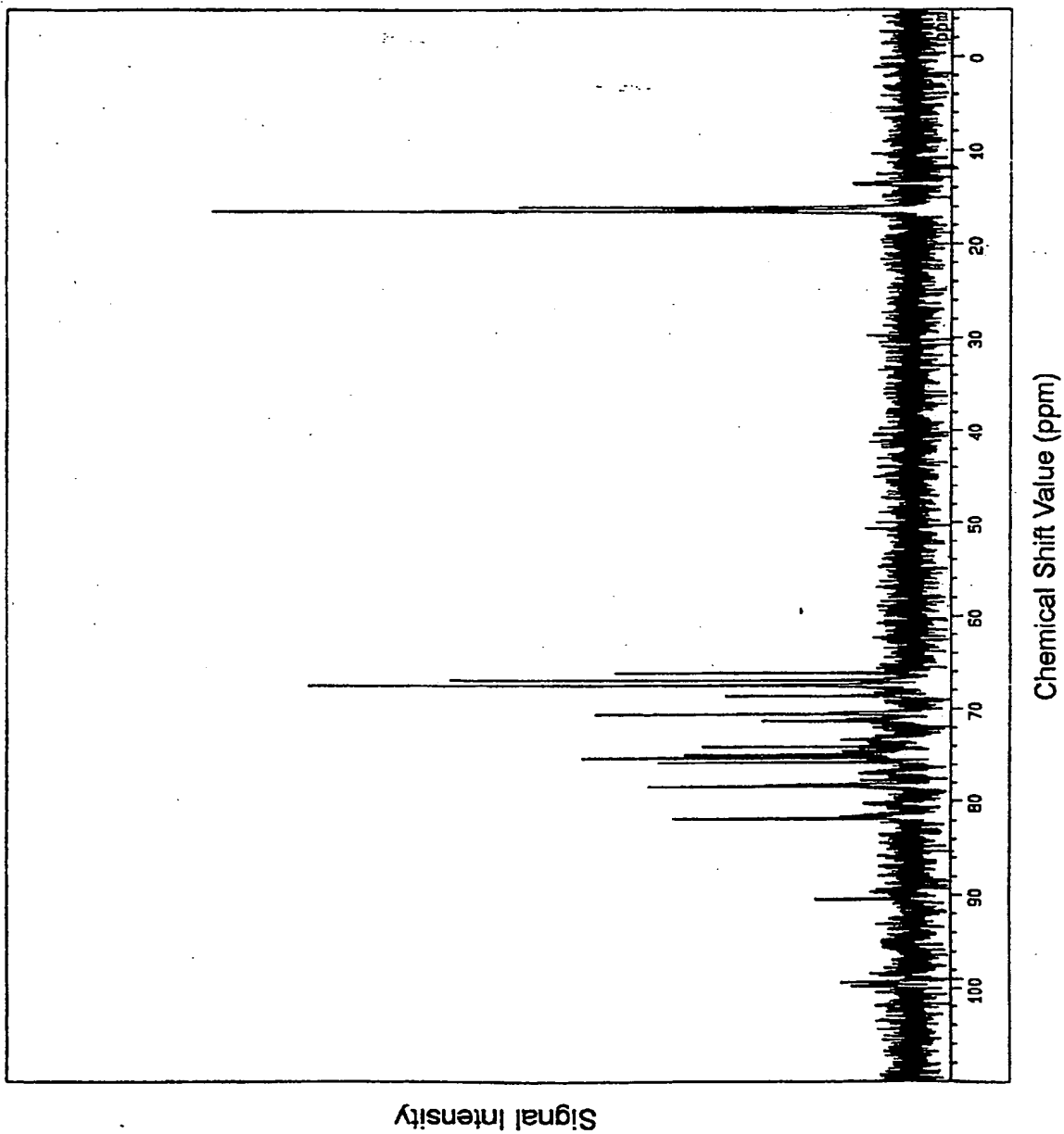

Fig. 6

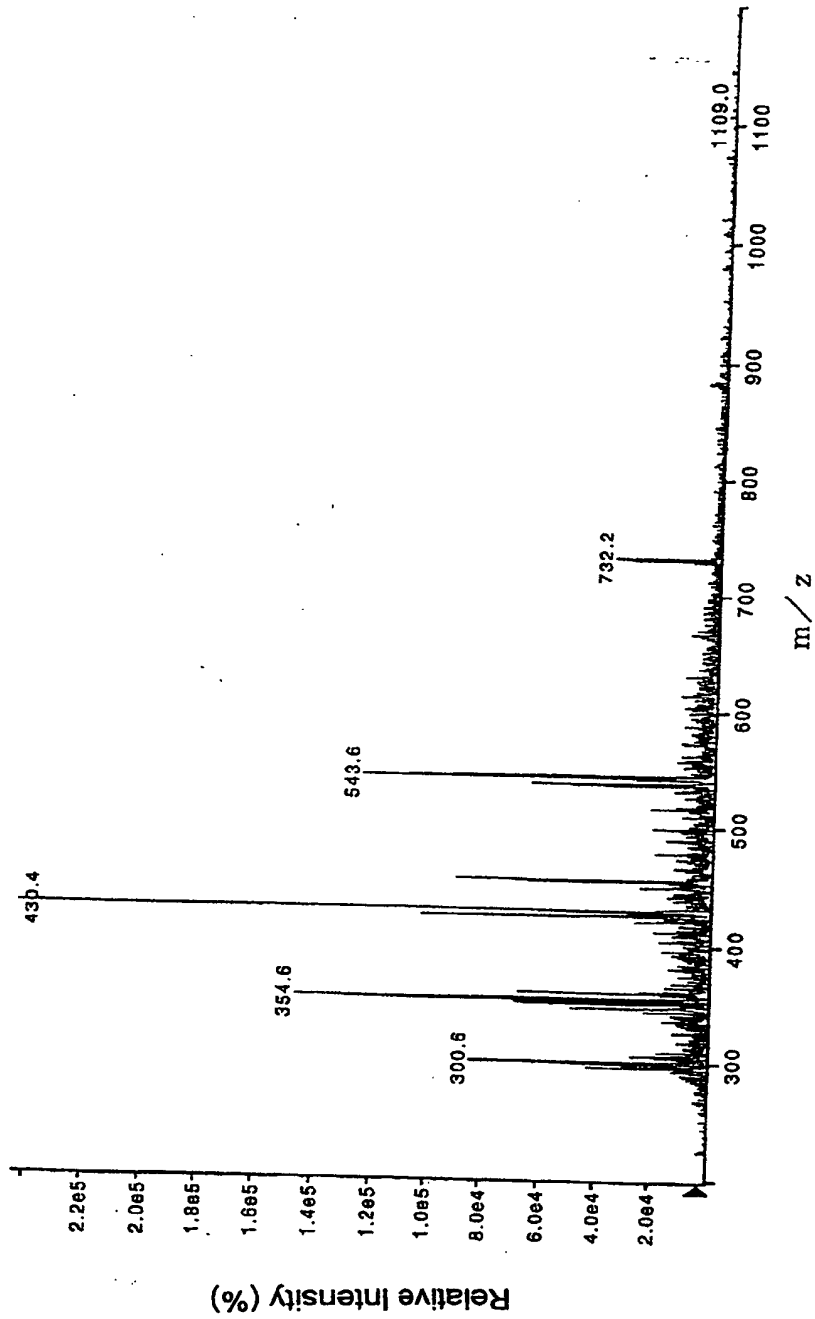

Fig. 7

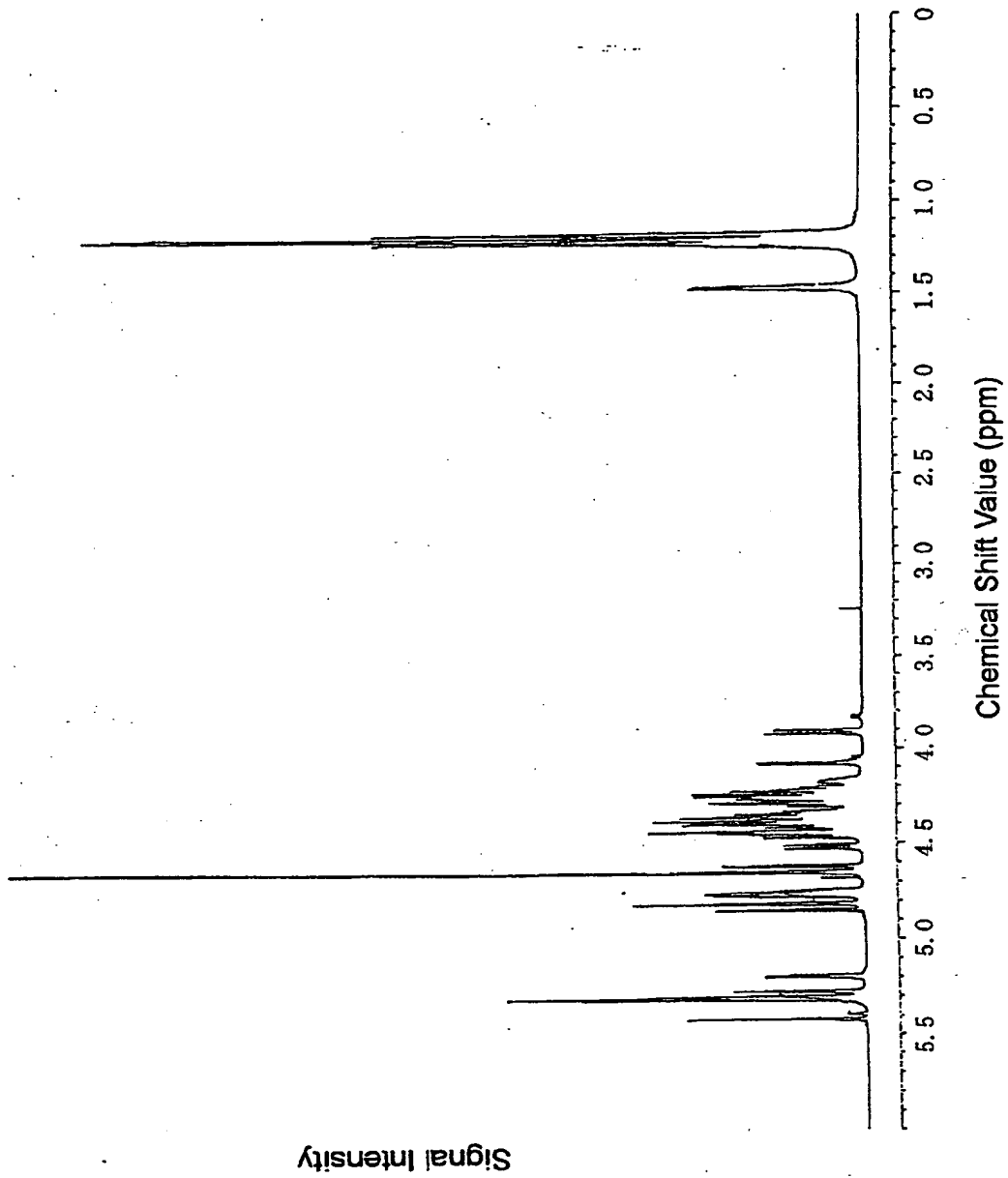

Fig. 8

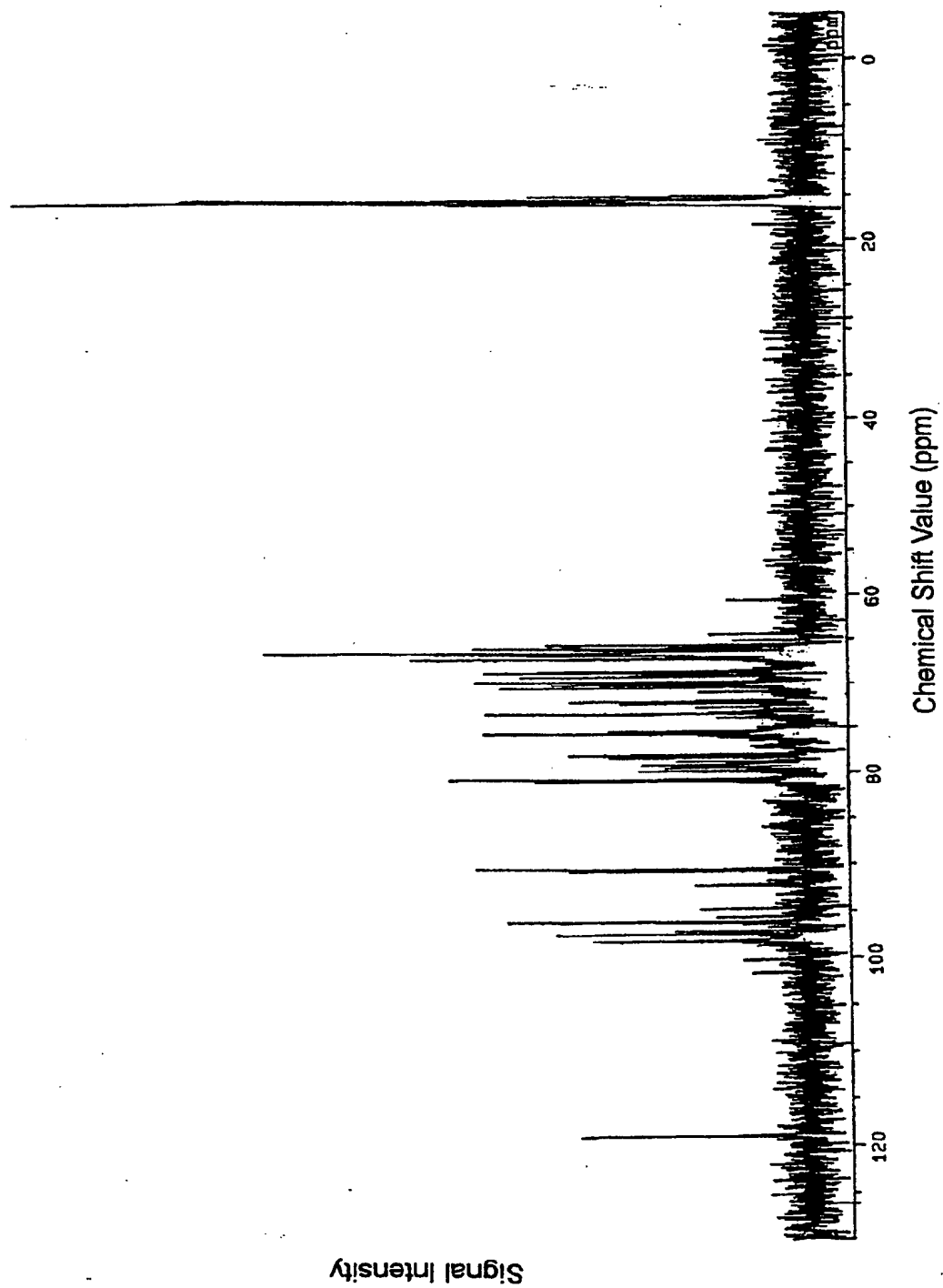

Fig. 9

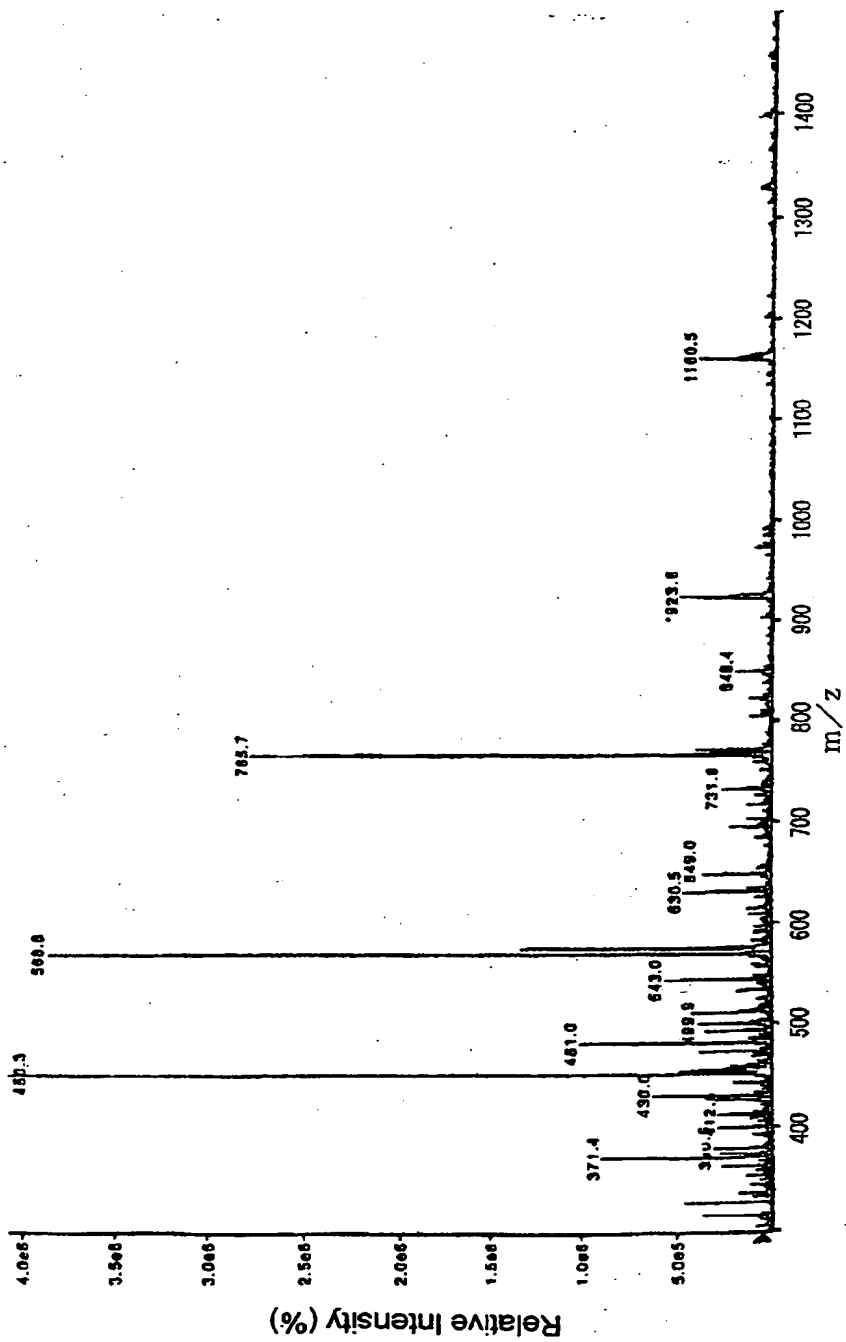

Fig. 1 0

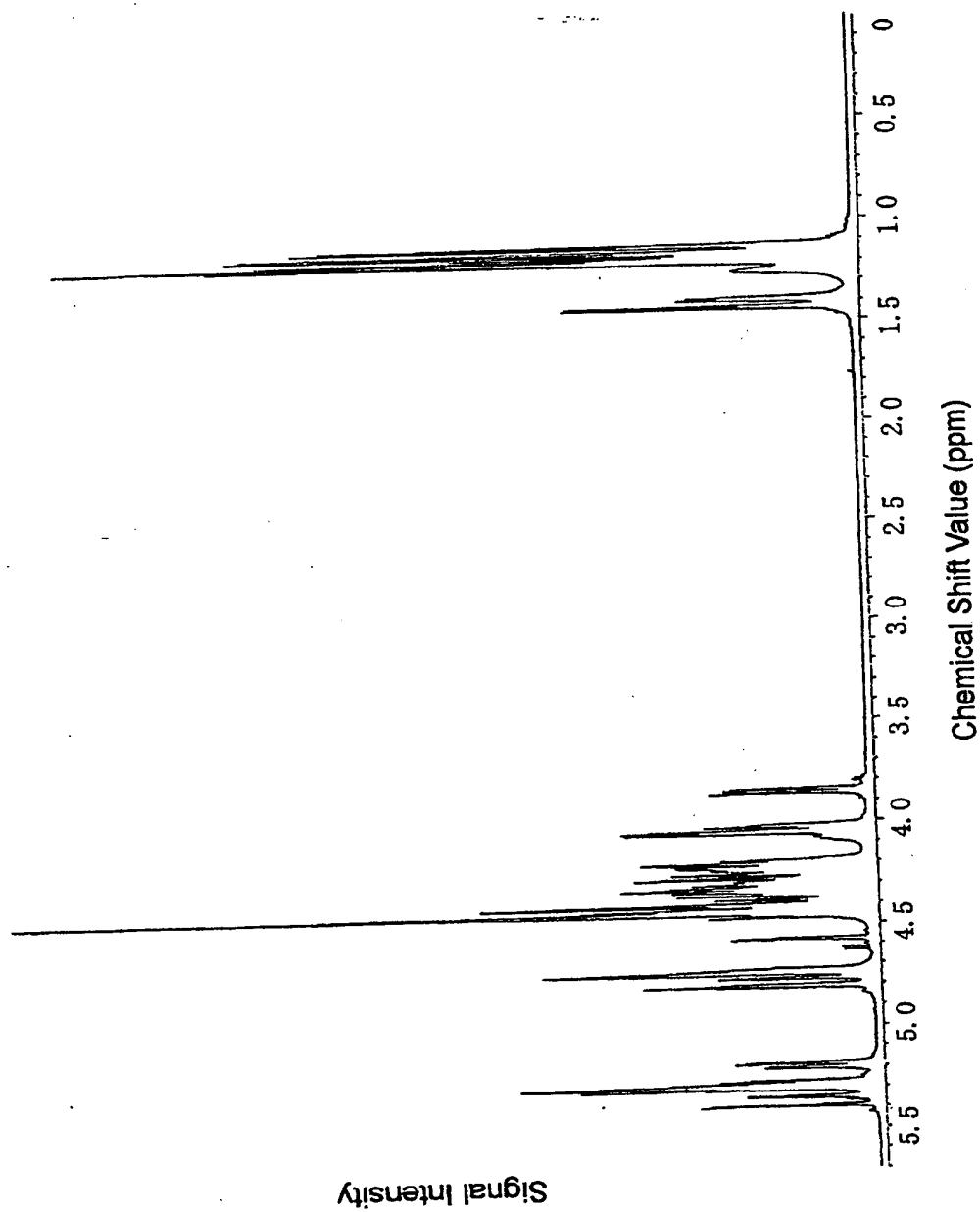

Fig. 1 1

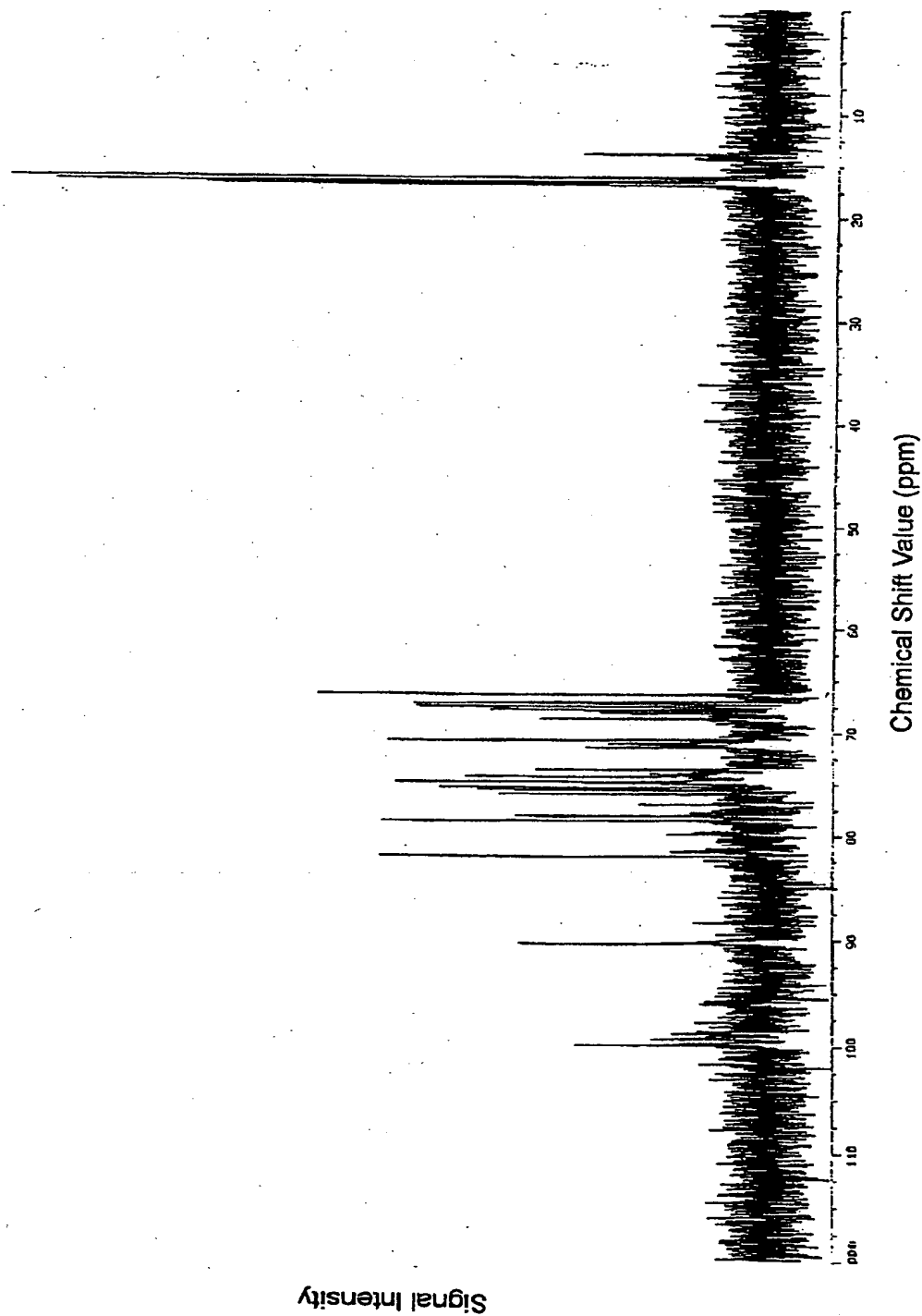

Fig. 1 2

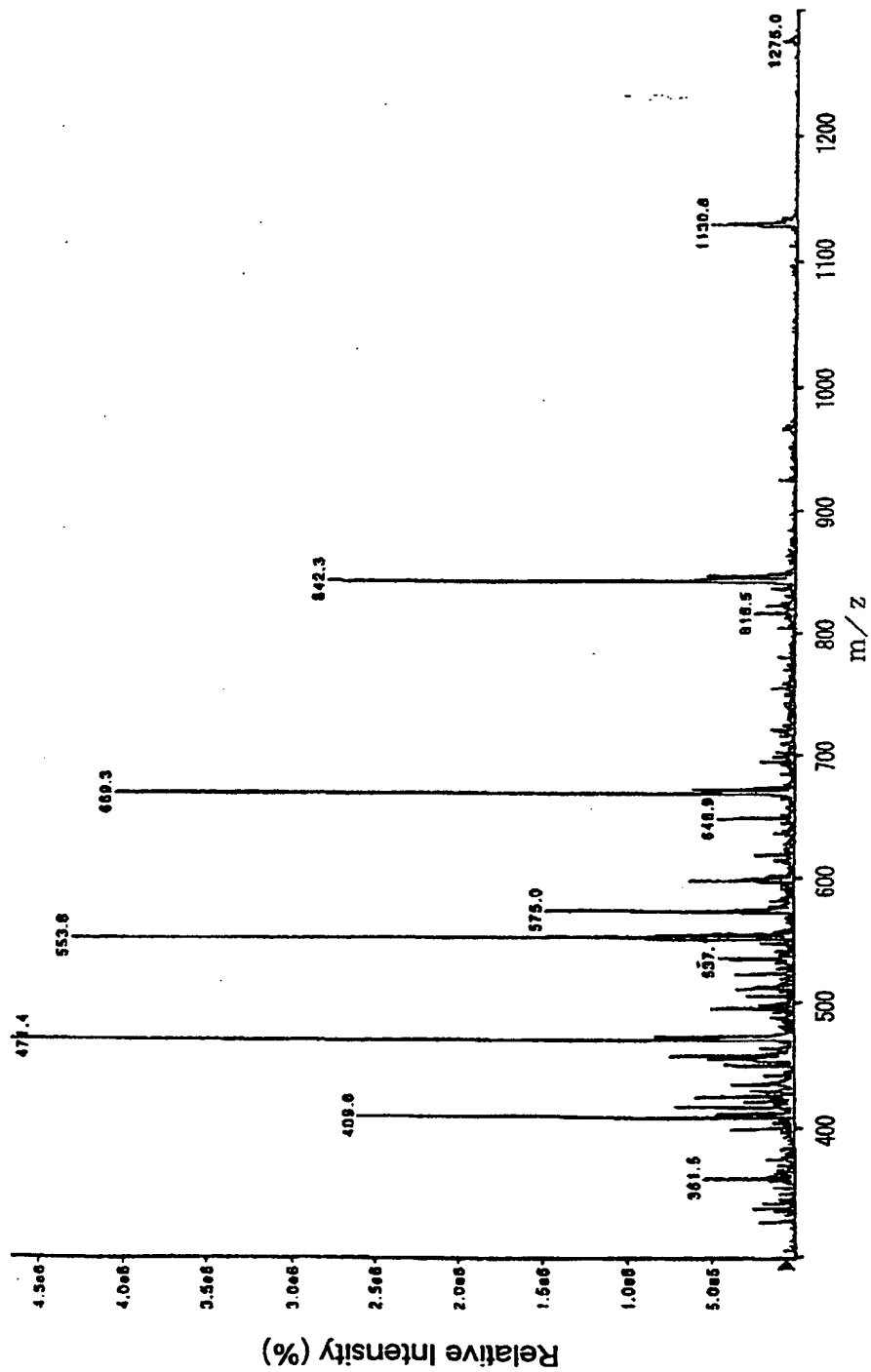

Fig. 1 3

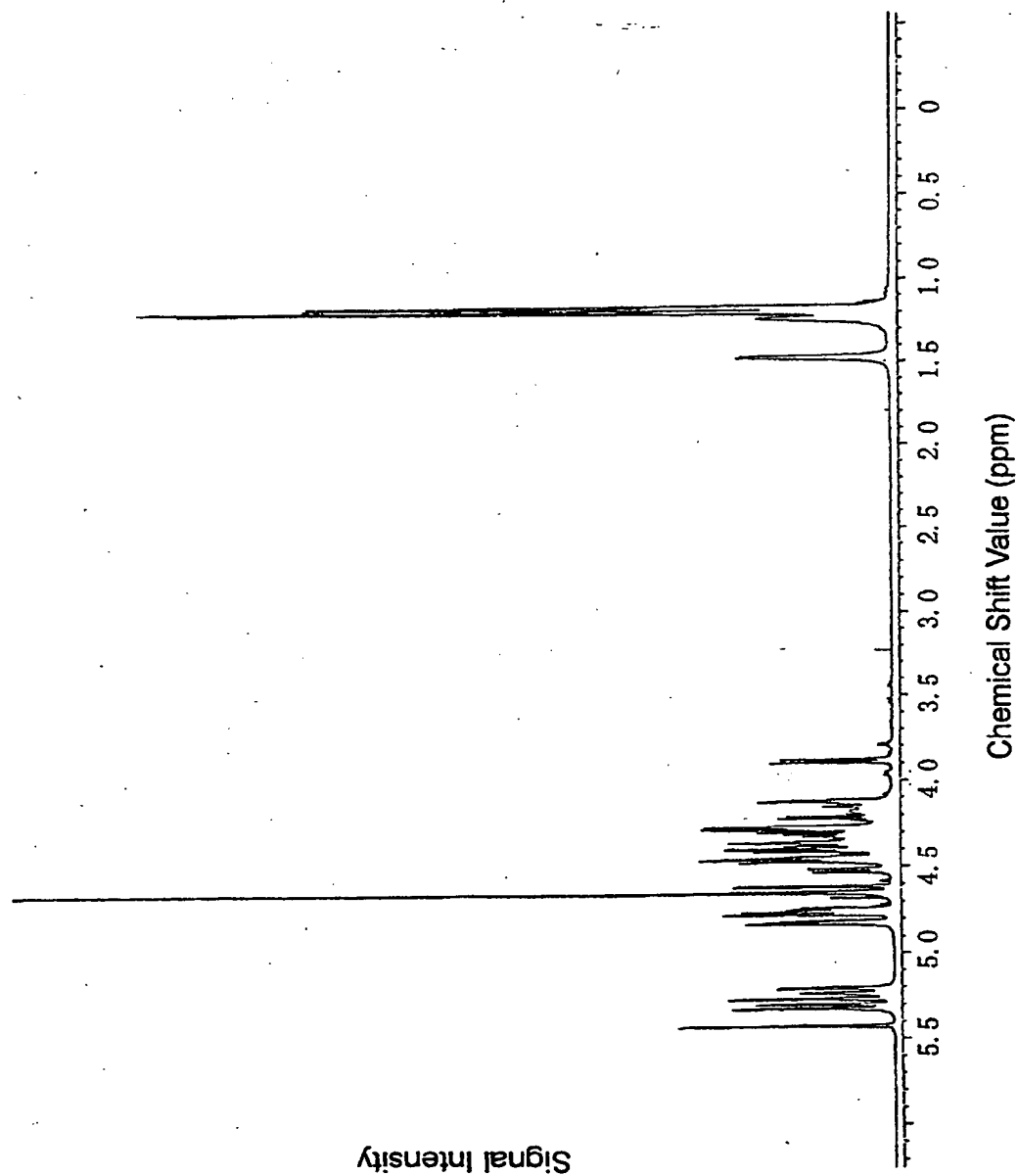

Fig. 1 4

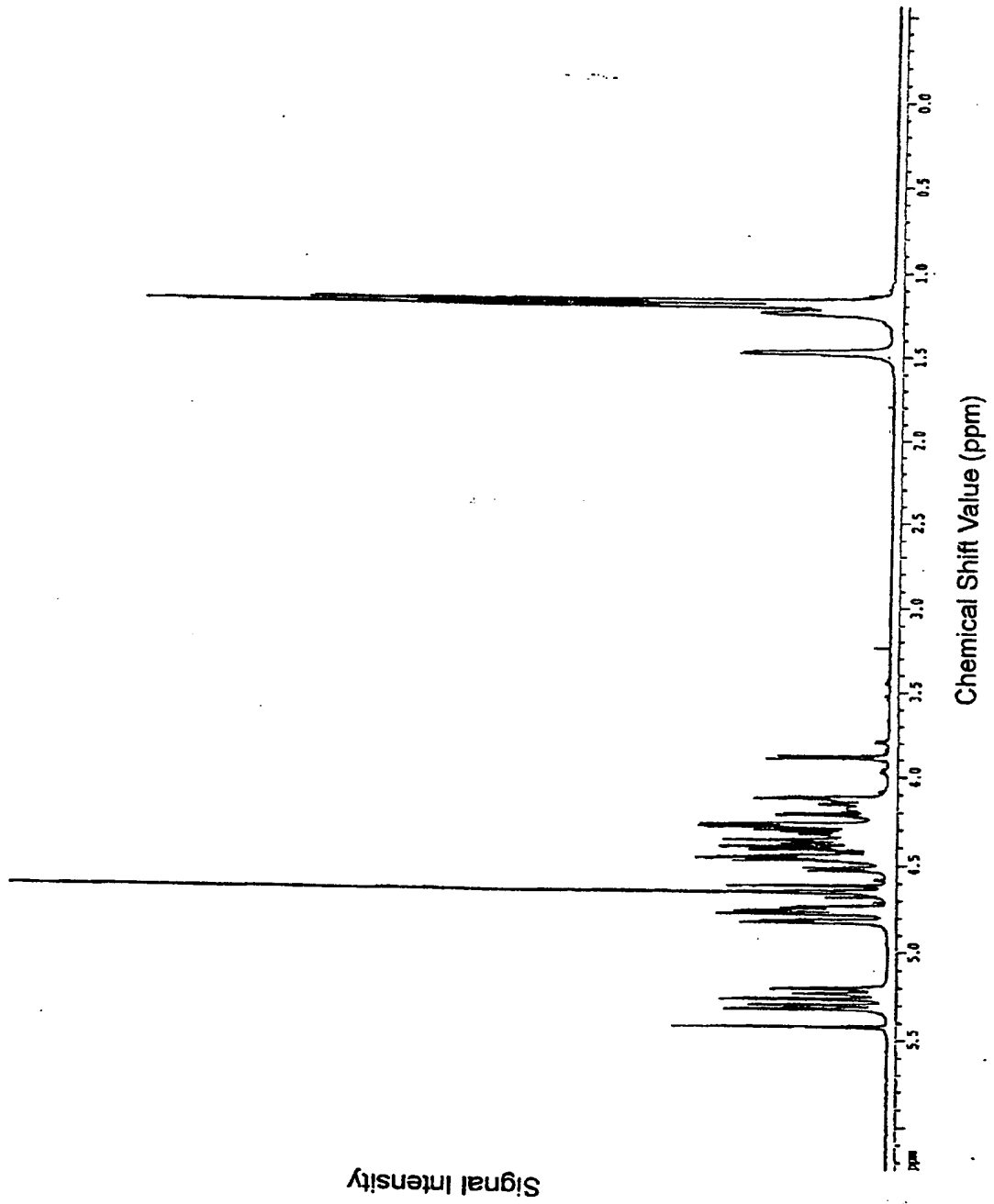

Fig. 1 5

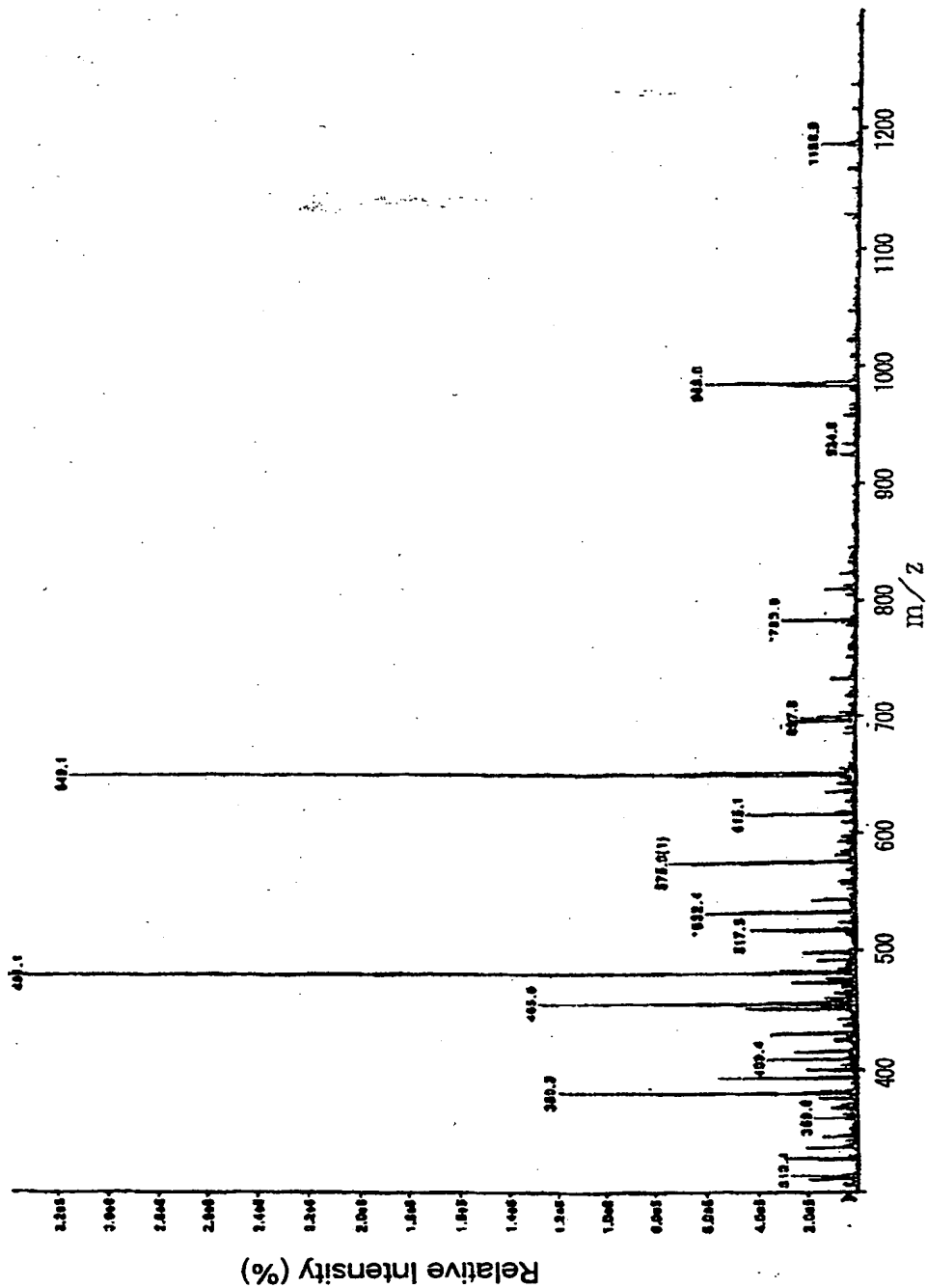

Fig. 1 6

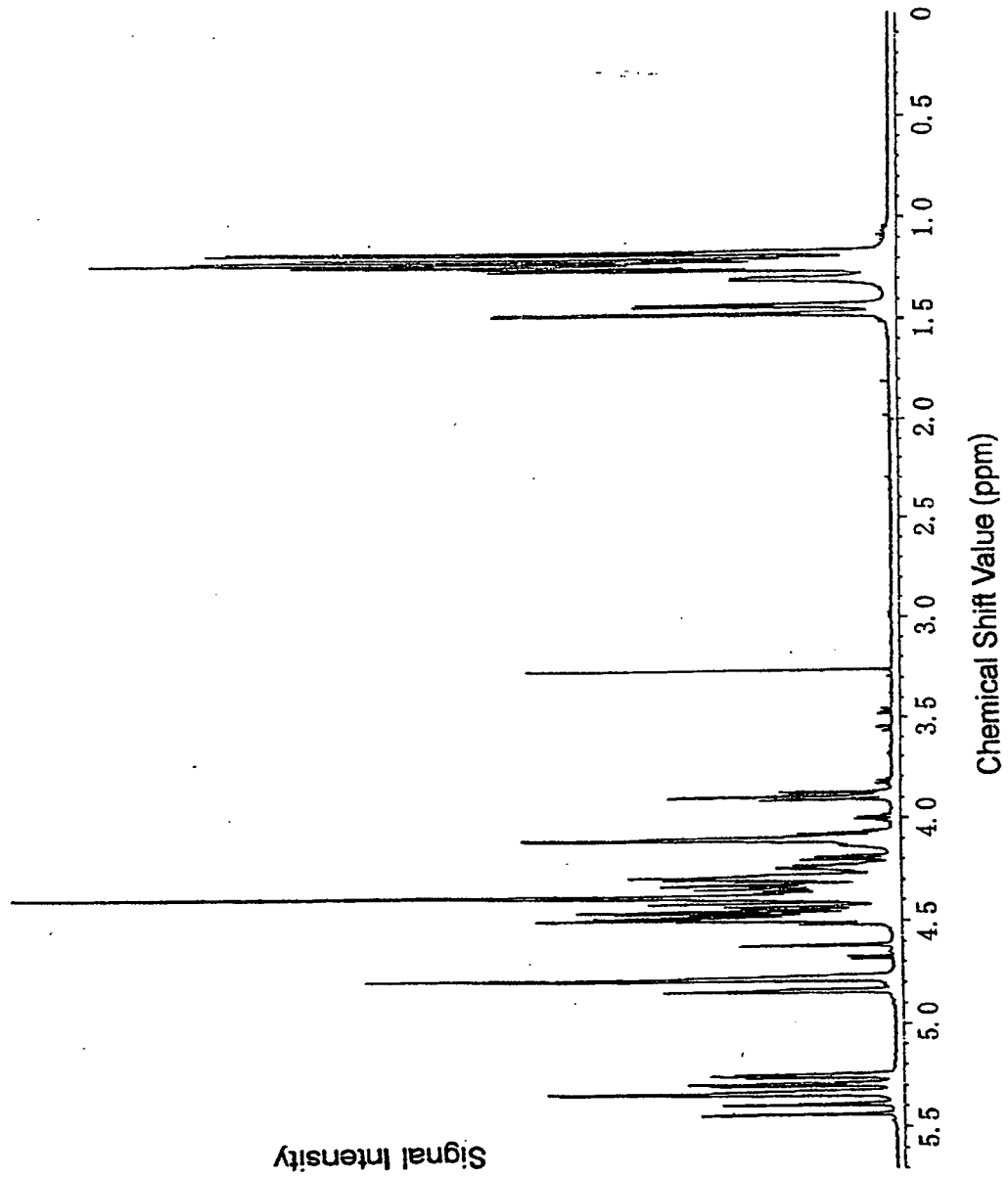

Fig. 1 7

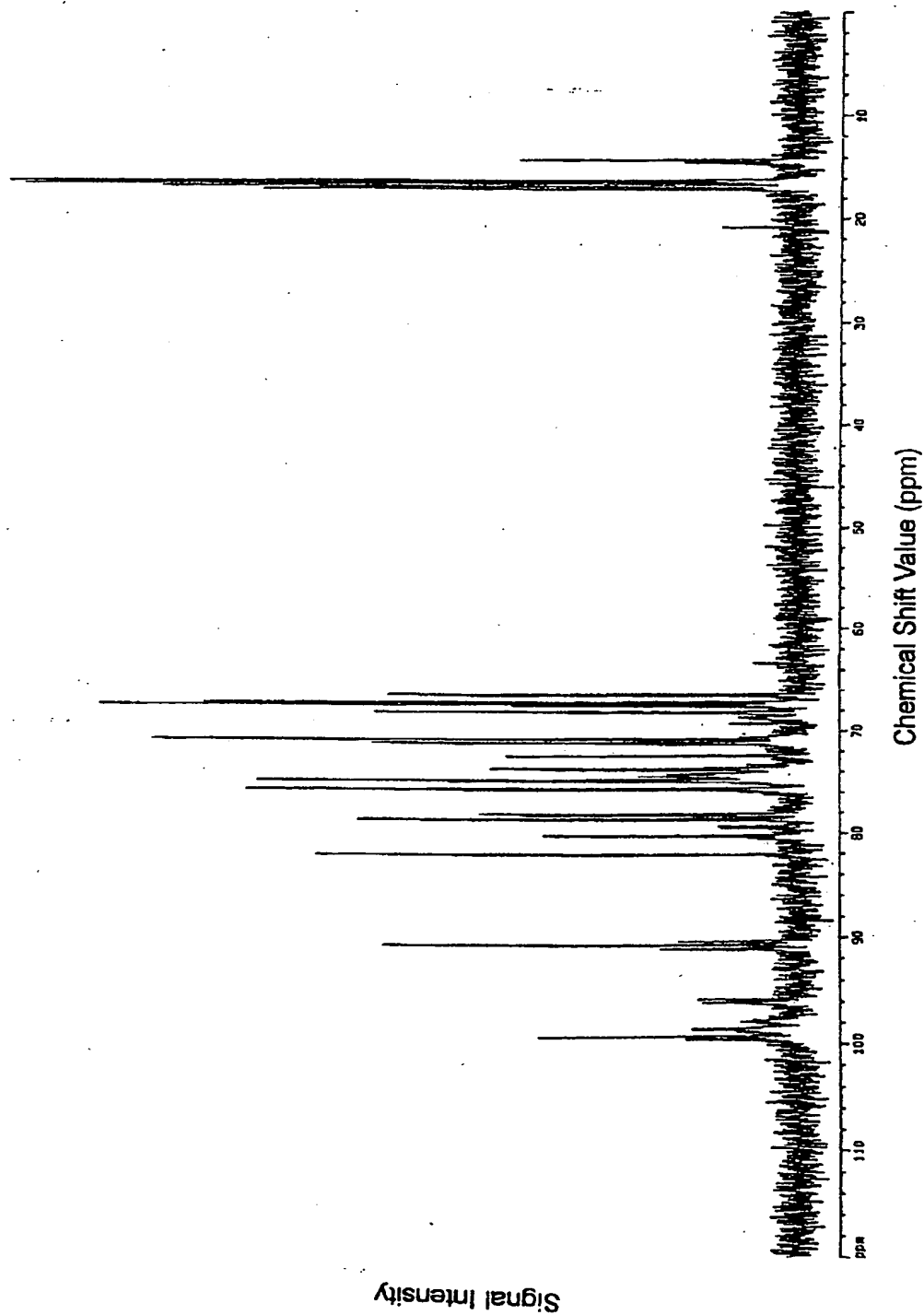

Fig. 1 8

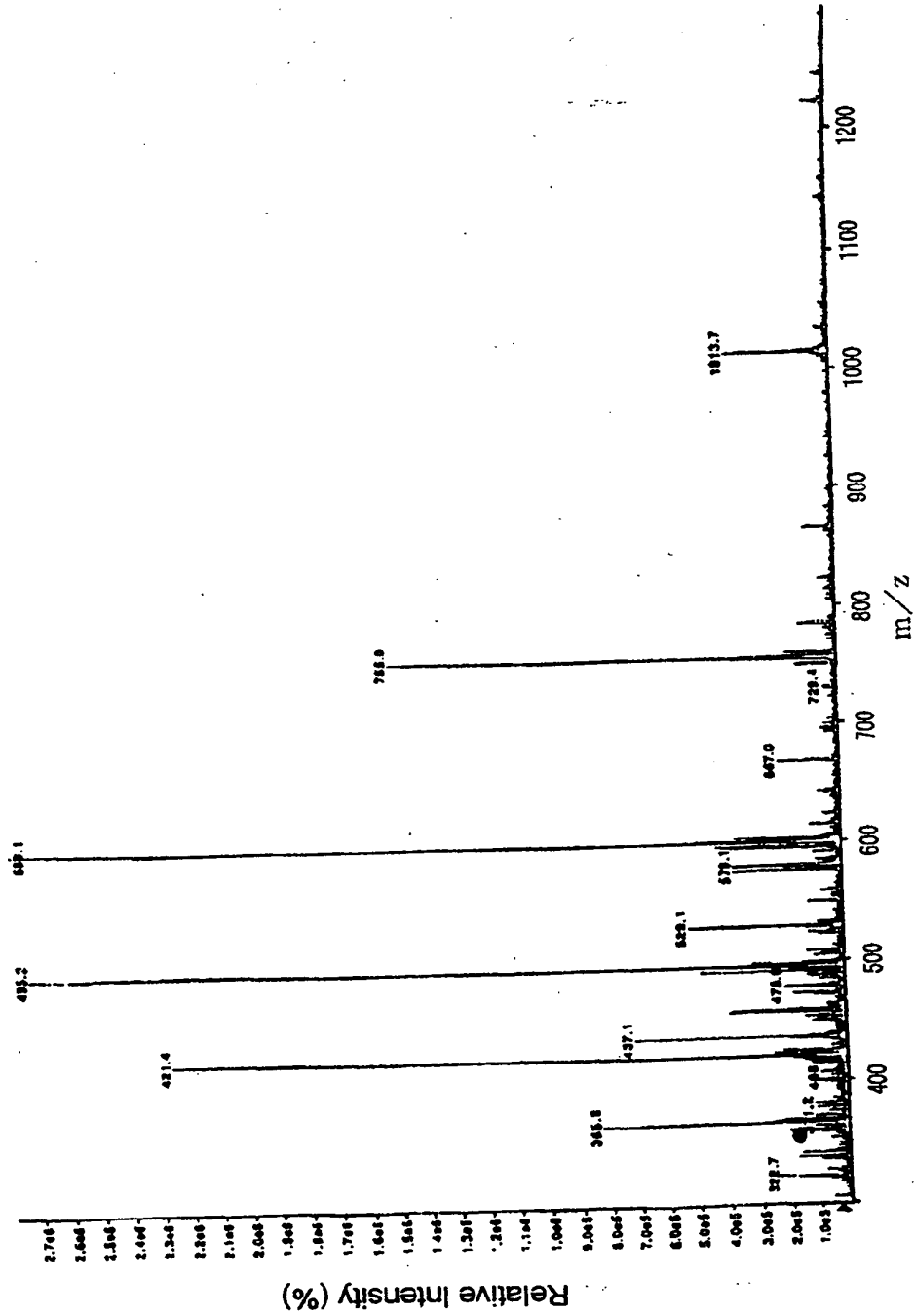

Fig. 1 9

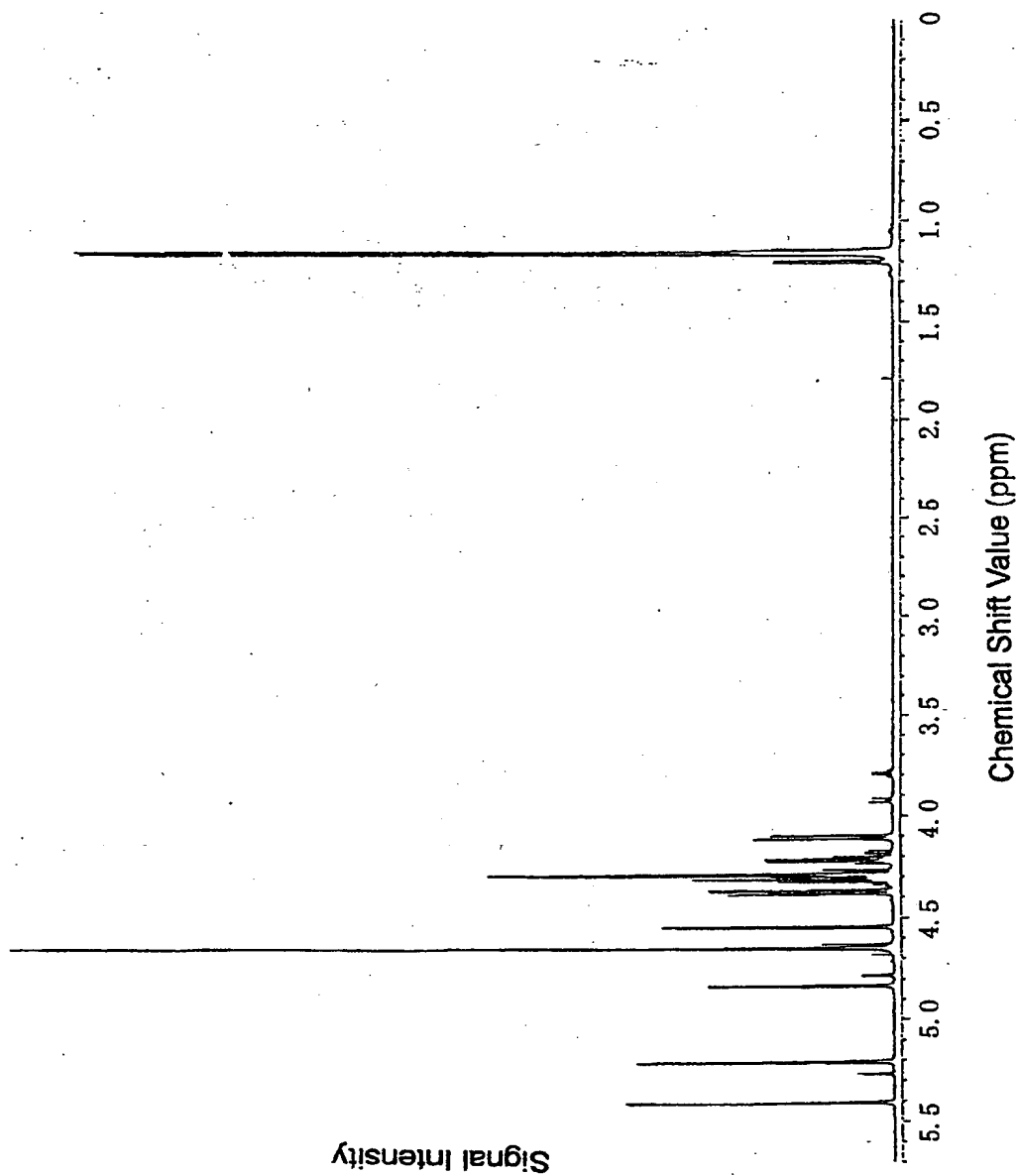

Fig. 2 0

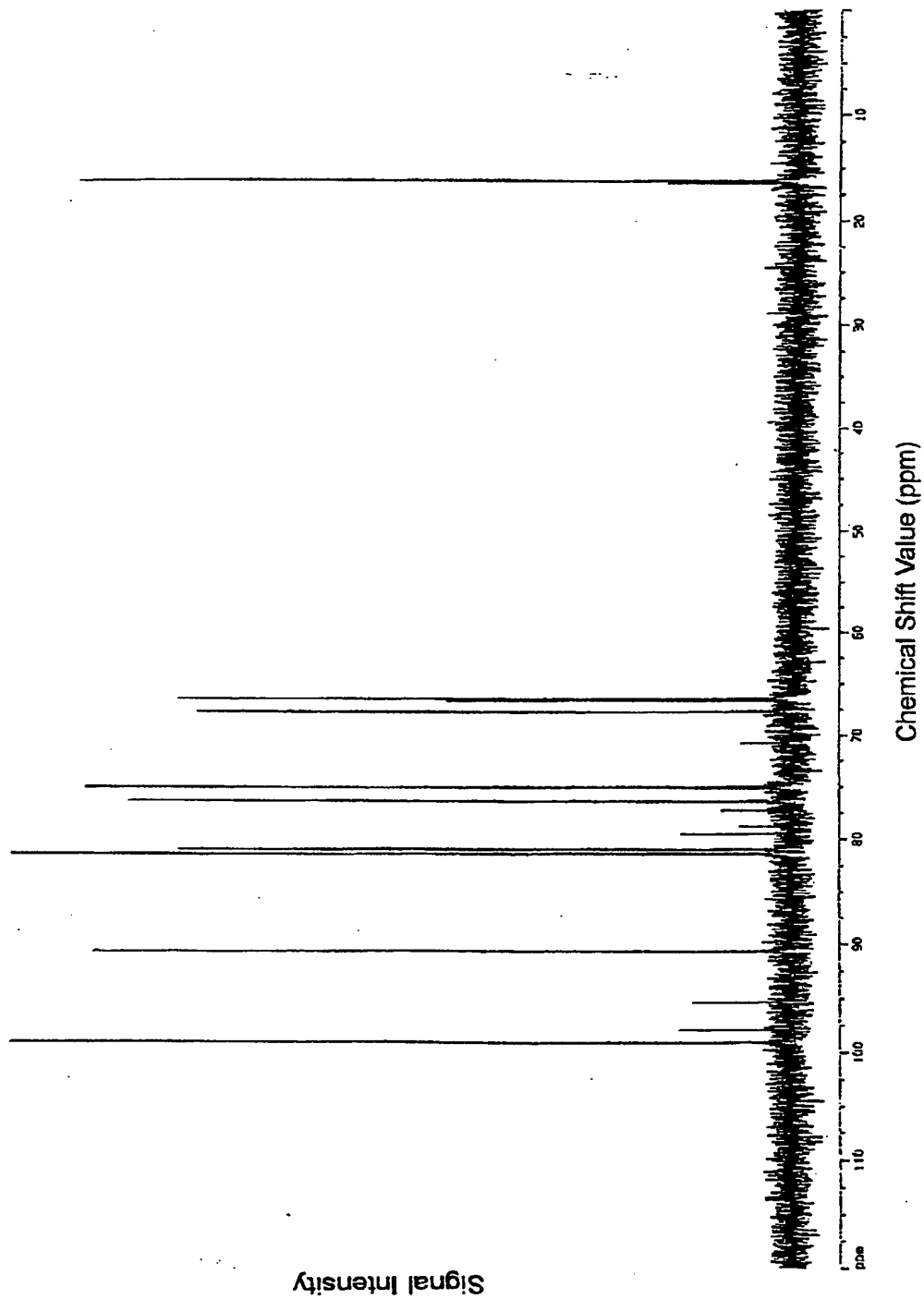

Fig. 2 1

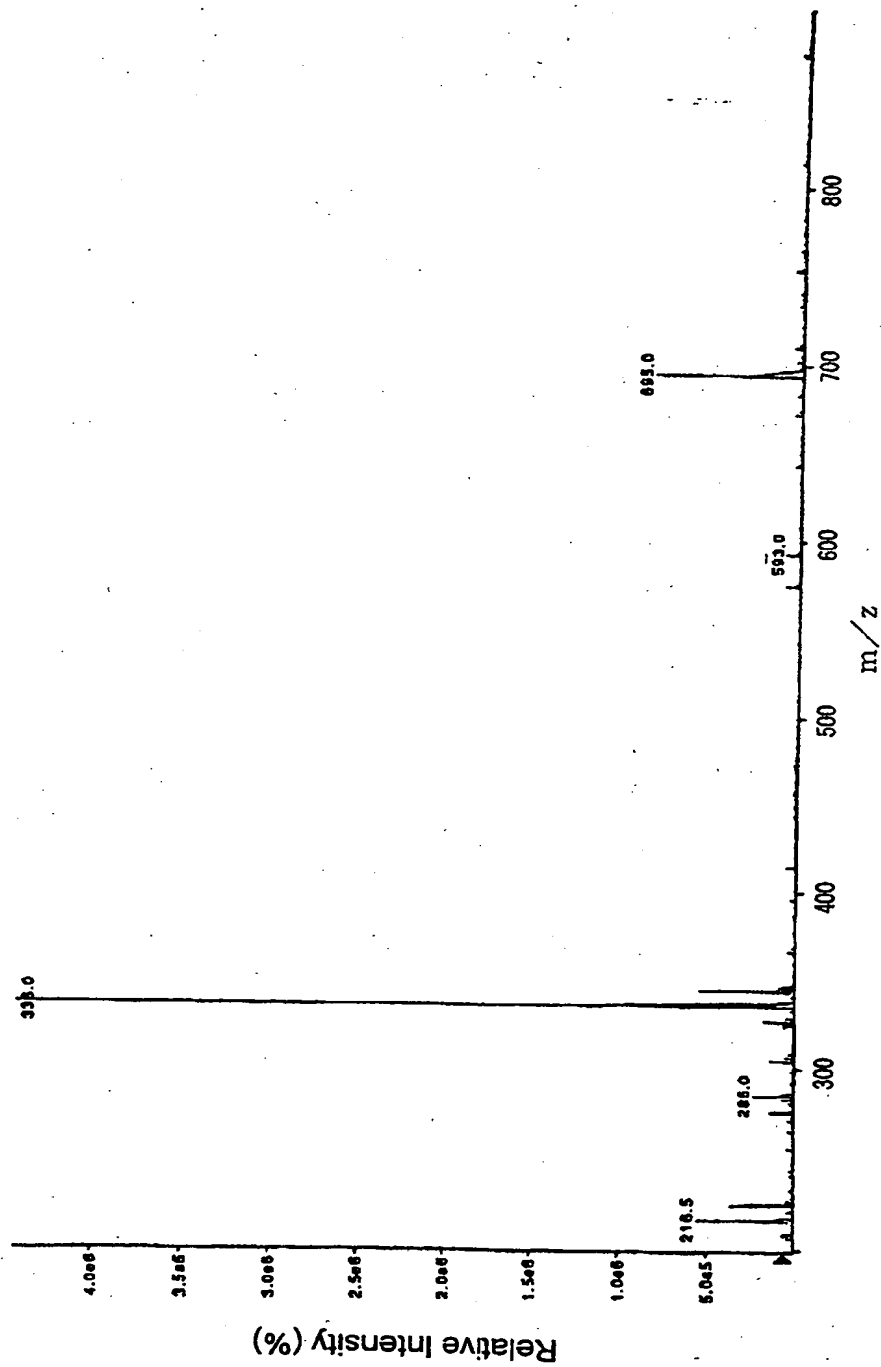

Fig. 2 2

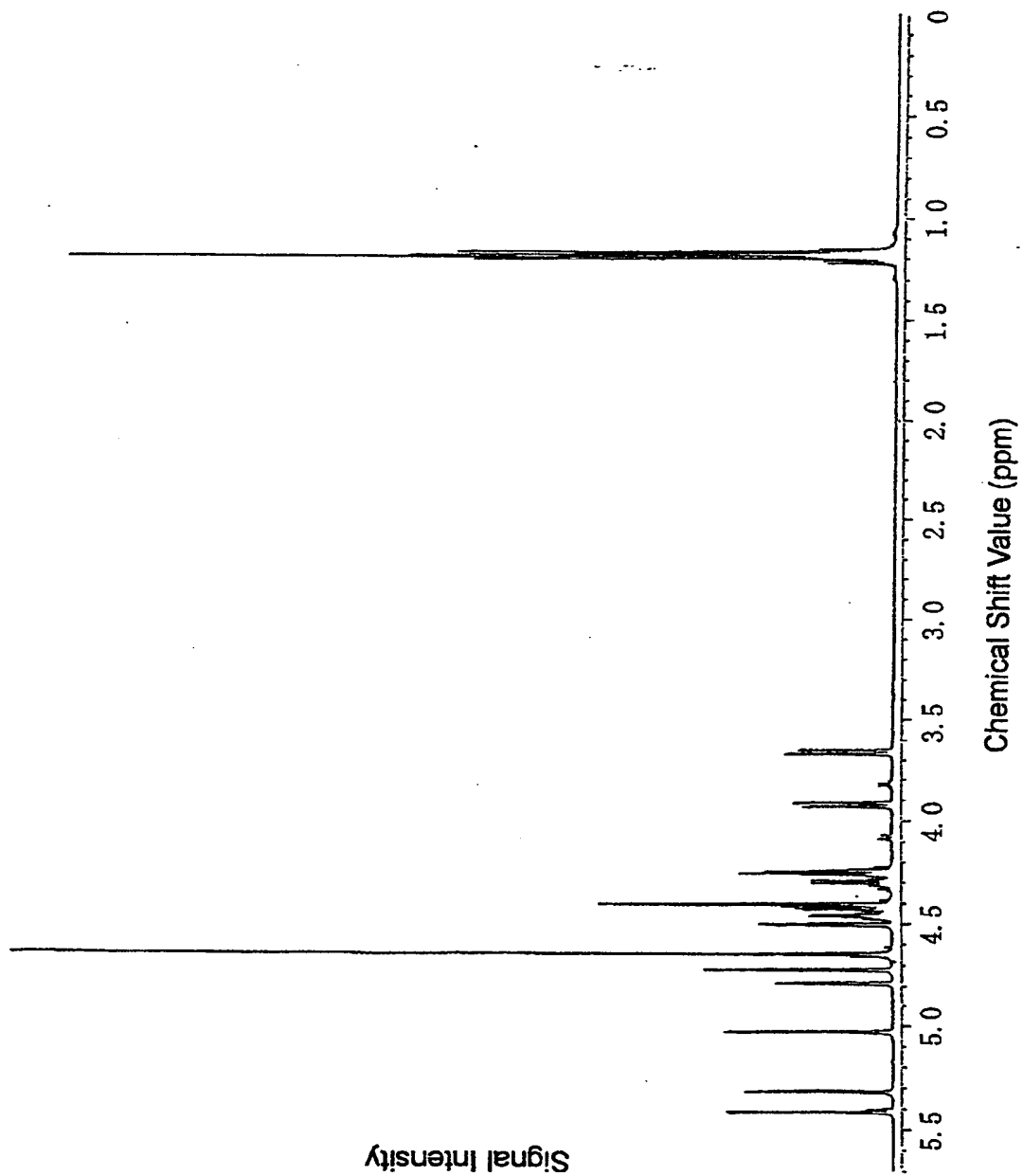

Fig. 2 3

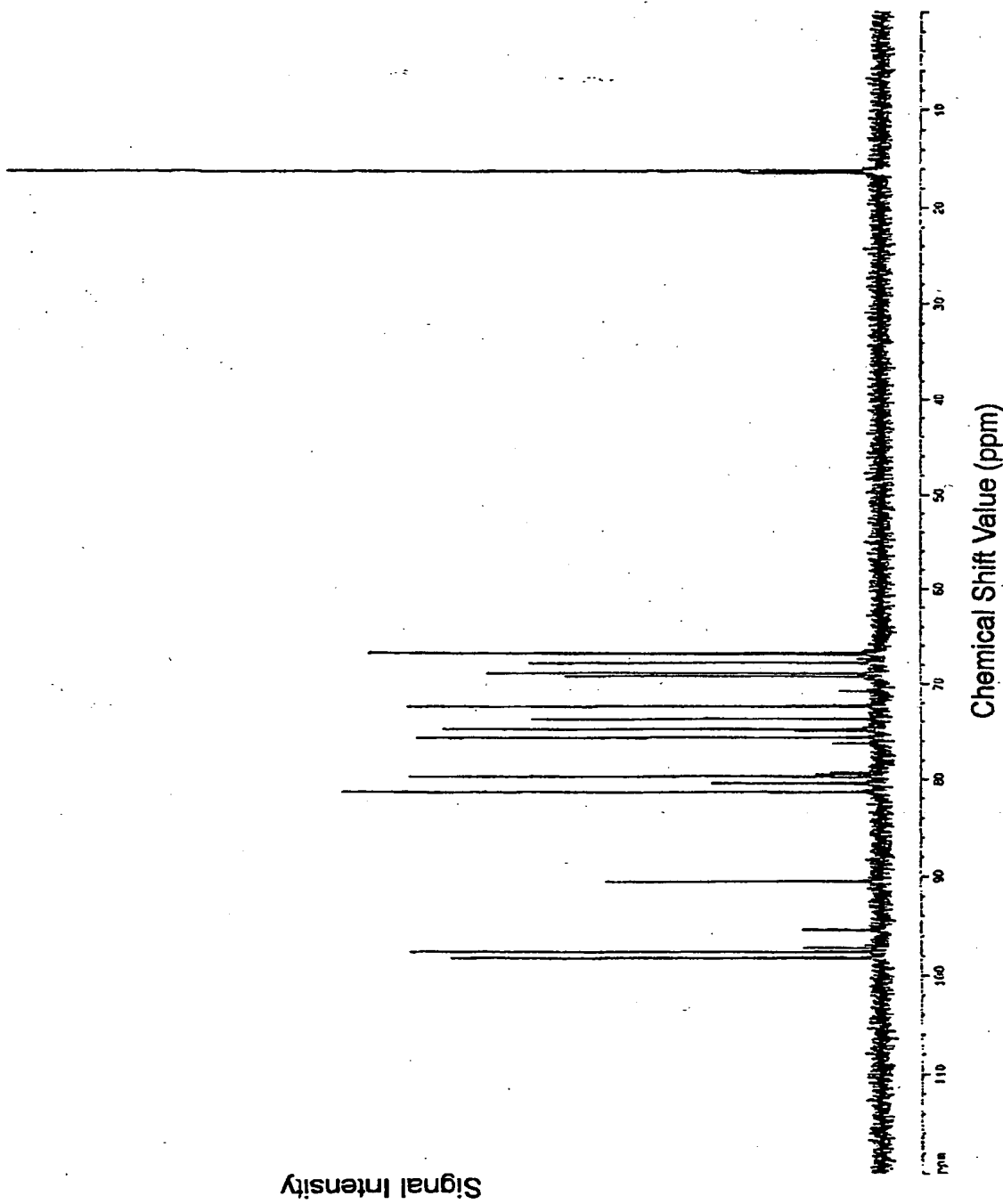

Fig. 2 4

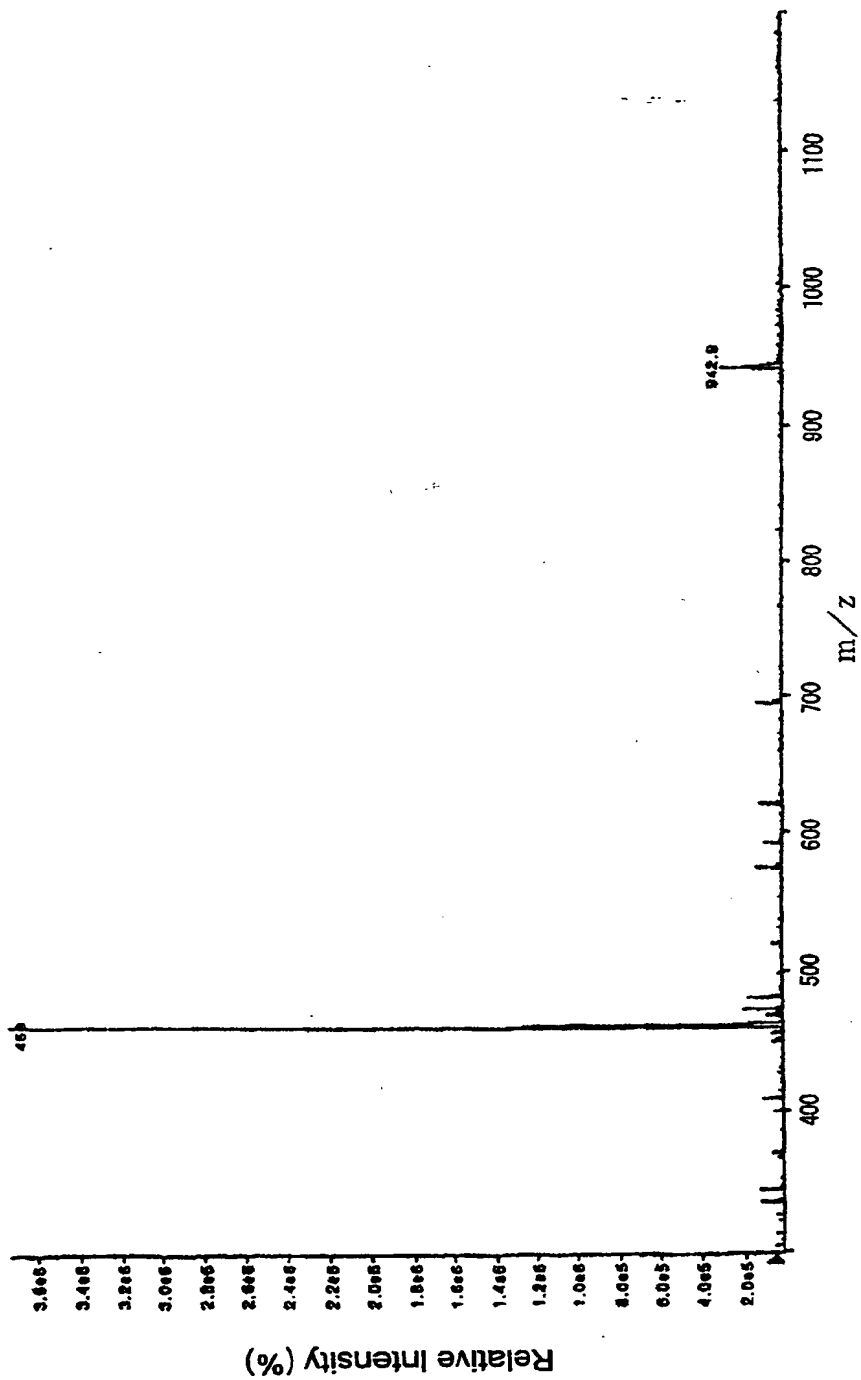

Fig. 2 5

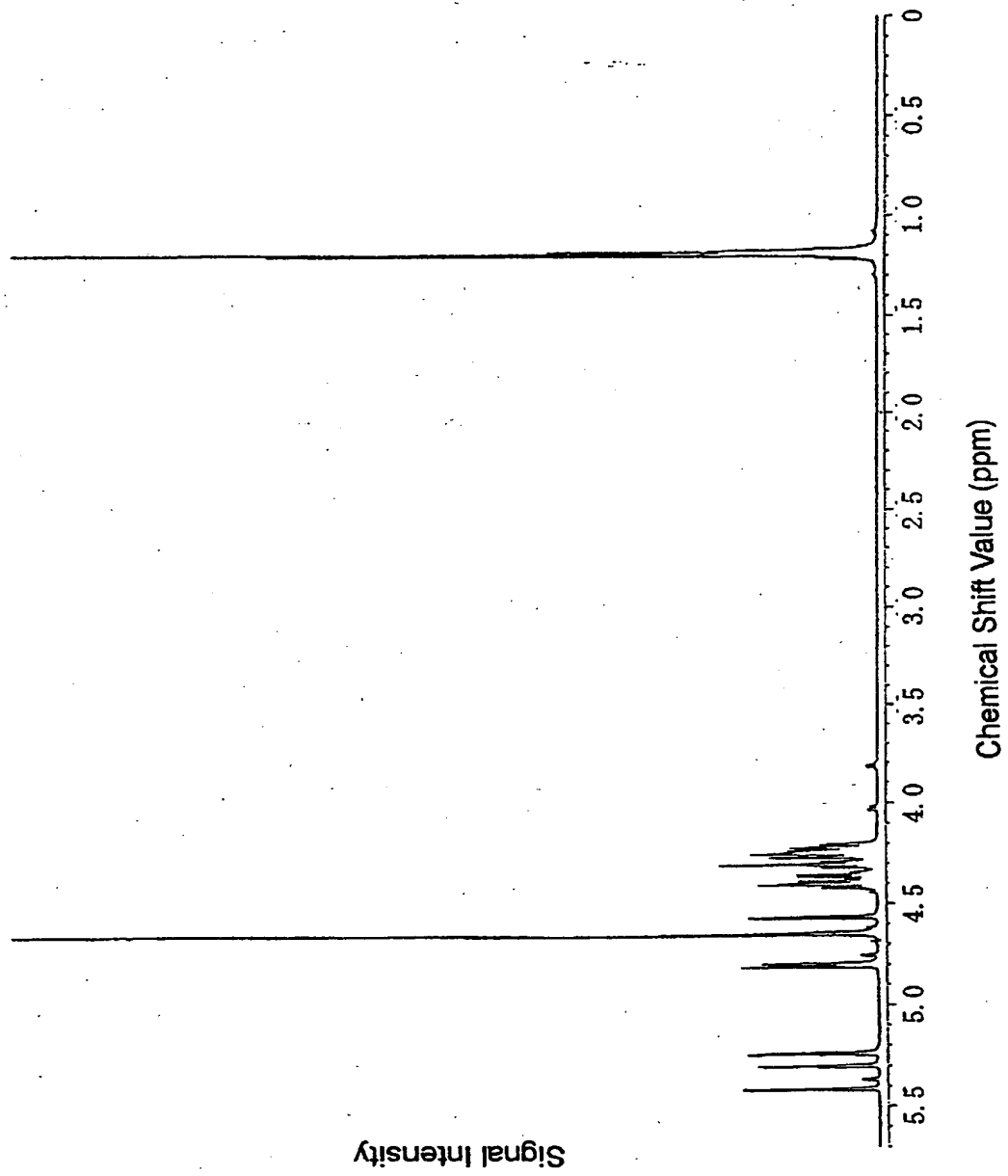

Fig. 2 6

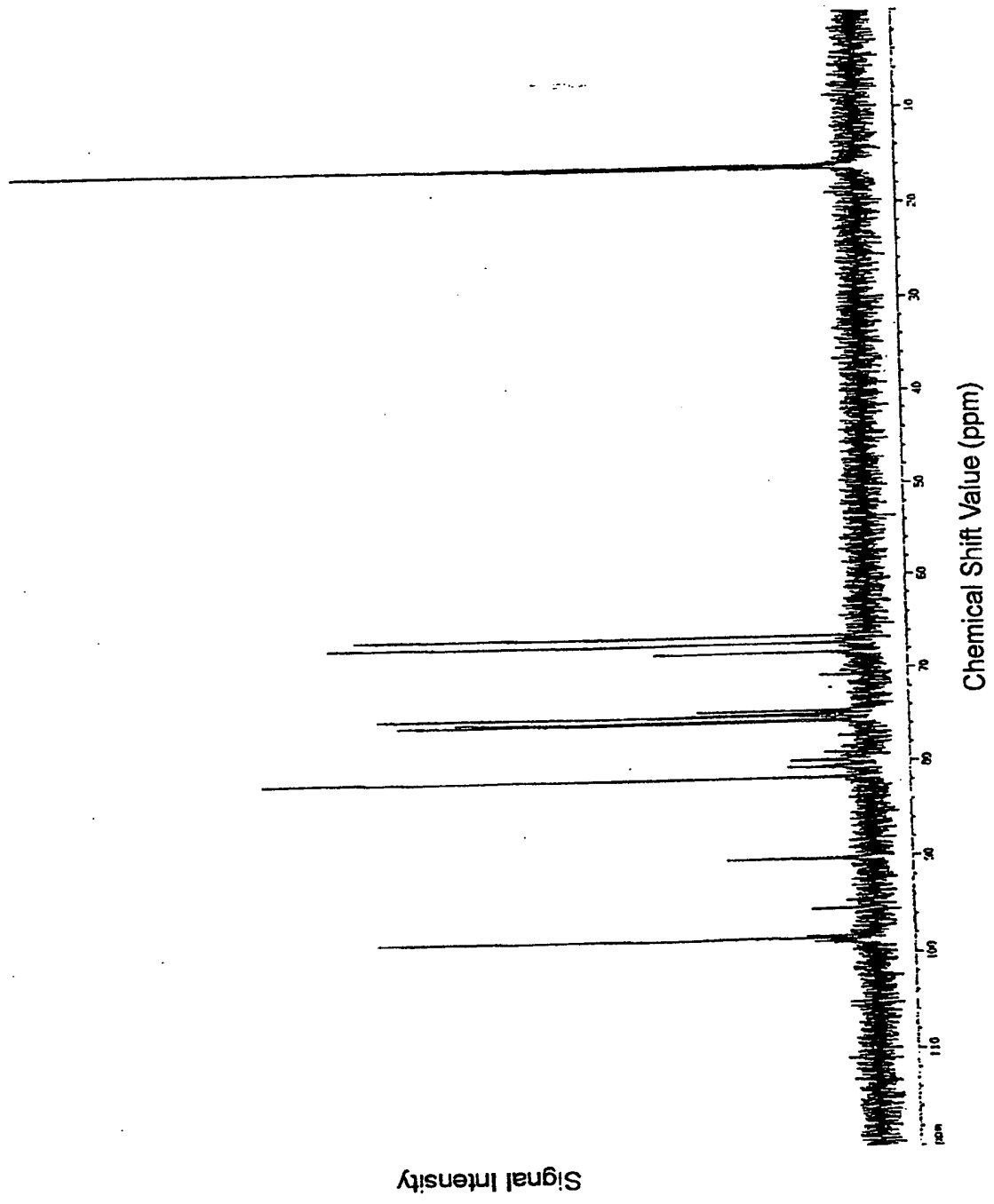
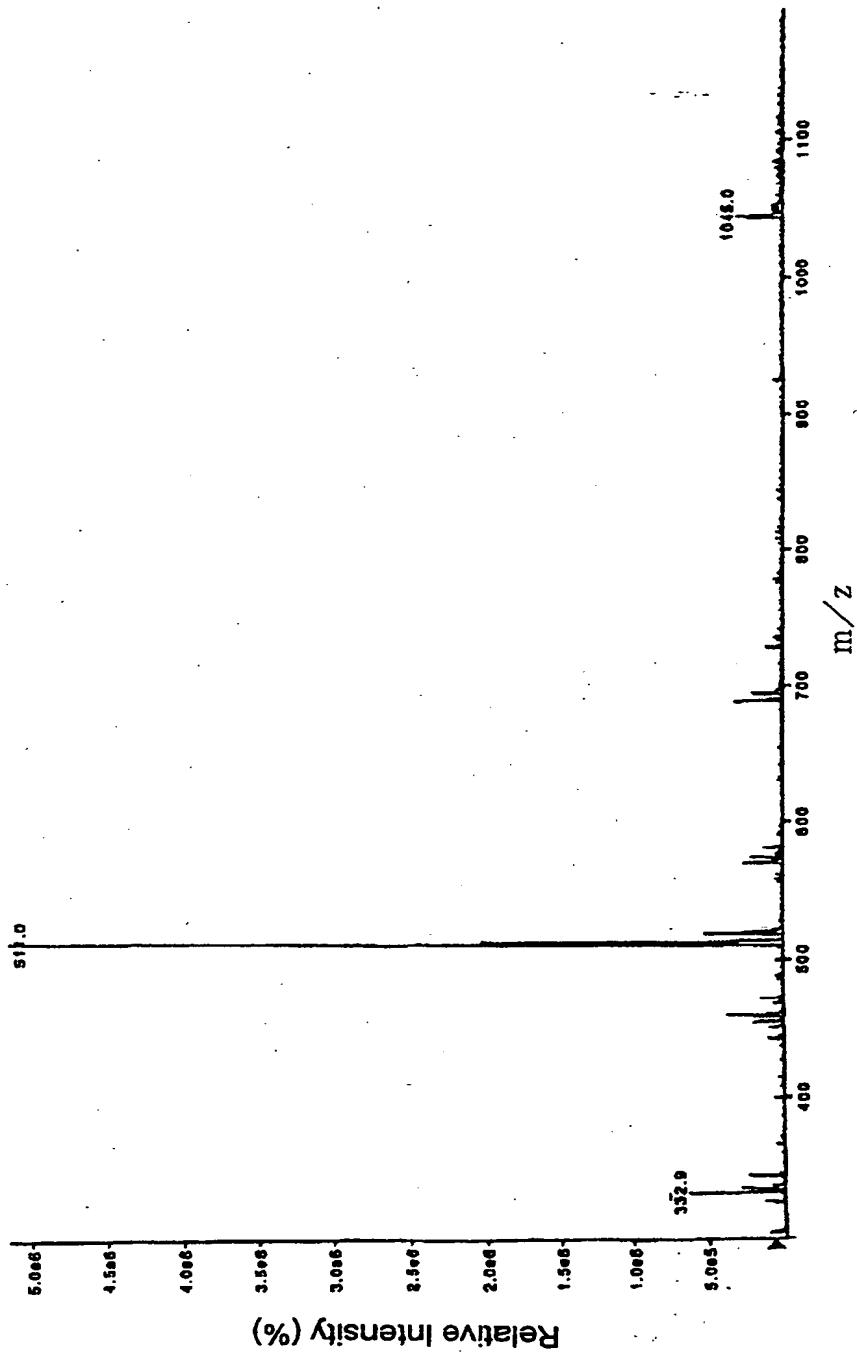

Fig. 2 7



1
2
3
4
5

(19)



Europäisches Patentamt
European Patent Office
Office européen des brevets



(11)

EP 1 306 389 A3

(12)

EUROPEAN PATENT APPLICATION

(88) Date of publication A3:
08.10.2003 Bulletin 2003/41

(51) Int Cl.7: **C08B 37/00**, C07H 3/06,
C07H 3/04

(43) Date of publication A2:
02.05.2003 Bulletin 2003/18

(21) Application number: **02023064.5**

(22) Date of filing: **16.10.2002**

(84) Designated Contracting States:
**AT BE BG CH CY CZ DE DK EE ES FI FR GB GR
IE IT LI LU MC NL PT SE SK TR**
Designated Extension States:
AL LT LV MK RO SI

- **Amarume, Hitomi**
Hirosaki-shi, Aomori (JP)
- **Kawai, Takashi**
Kusatsu-shi, Shiga (JP)
- **Kojima, Kaoru**
Hirosaki-shi, Aomori (JP)
- **Shimanaka, Kazuo**
Takatsuki-shi, Osaka (JP)
- **Ikai, Katsushige**
Koka-gun, Shiba (JP)
- **Kato, Ikunoshin**
Uji-shi, Kyoto (JP)

(30) Priority: **24.10.2001 JP 2001325960**

(83) Declaration under Rule 28(4) EPC (expert solution)

(71) Applicant: **TAKARA BIO INC.**
Otsu-shi, Shiga (JP)

(74) Representative: **Grund, Martin, Dr. et al**
Dr. Volker Vossius
Patent- & Rechtsanwaltskanzlei
Gelbelstrasse 6
81679 München (DE)

(72) Inventors:
• **Sakai, Takeshi**
Kusatsu-shi, Shiga (JP)

(54) **Sulfated fucan oligosaccharide**

(57) A smaller molecule obtainable by allowing a sulfated fucan-digesting enzyme which digests a novel sulfated polysaccharide derived from an alga belonging to Laminariales to act on a sulfated fucan, and a method for producing the same.

EP 1 306 389 A3



European Patent Office

EUROPEAN SEARCH REPORT

Application Number

EP 02 02 3064

DOCUMENTS CONSIDERED TO BE RELEVANT		
Category	Citation of document with indication, where appropriate, of relevant passages	Relevant to claim
A	WO 90 15823 A (IFREMER) 27 December 1990 (1990-12-27) ---	
A	WO 97 08206 A (CENTRE NAT RECH SCIENT ;IFREMER (FR); NARDELLA ALAIN (FR); CHAUBET) 6 March 1997 (1997-03-06) -----	
		CLASSIFICATION OF THE APPLICATION (Int.Cl.7) C08B37/00 C07H3/06 C07H3/04
		TECHNICAL FIELDS SEARCHED (Int.Cl.7) C08B C07H
The present search report has been drawn up for all claims		
Place of search	Date of completion of the search	Examiner
MUNICH	19 August 2003	Klein, D
CATEGORY OF CITED DOCUMENTS X : particularly relevant if taken alone Y : particularly relevant if combined with another document of the same category A : technological background O : non-written disclosure P : intermediate document T : theory or principle underlying the invention E : earlier patent document, but published on, or after the filing date D : document cited in the application L : document cited for other reasons & : member of the same patent family, corresponding document		

EPO FORM 1503 03.92 (P/4/C01)

ANNEX TO THE EUROPEAN SEARCH REPORT
ON EUROPEAN PATENT APPLICATION NO.

EP 02 02 3064

This annex lists the patent family members relating to the patent documents cited in the above-mentioned European search report.
The members are as contained in the European Patent Office EDP file on
The European Patent Office is in no way liable for these particulars which are merely given for the purpose of information.

19-08-2003

Patent document cited in search report	Publication date	Patent family member(s)	Publication date
WO 9015823 A	27-12-1990	FR 2648463 A1	21-12-1990
		AT 131176 T	15-12-1995
		AT 196089 T	15-09-2000
		AU 5841090 A	08-01-1991
		CN 1051564 A	22-05-1991
		DD 296937 A5	19-12-1991
		DE 69023957 D1	18-01-1996
		DE 69023957 T2	04-07-1996
		DE 69033626 D1	12-10-2000
		DE 69033626 T2	23-05-2001
		EP 0403377 A1	19-12-1990
		EP 0676207 A2	11-10-1995
		ES 2152998 T3	16-02-2001
		WO 9015823 A1	27-12-1990
		IE 902153 A1	02-01-1991
		JP 3042543 B2	15-05-2000
		JP 4506089 T	22-10-1992
		PT 94359 A	08-02-1991
US 5321133 A	14-06-1994		
WO 9708206 A	06-03-1997	FR 2738009 A1	28-02-1997
		DE 69602369 D1	10-06-1999
		DE 69602369 T2	18-11-1999
		EP 0846129 A1	10-06-1998
		WO 9708206 A1	06-03-1997
		JP 11511493 T	05-10-1999
		US 6028191 A	22-02-2000

EPOFORM P0459

For more details about this annex : see Official Journal of the European Patent Office, No. 12/82

THIS PAGE BLANK (USPTO)